



# *super* **BATRAY**™

## Specifications

Length: 54.5"  
Diameter 4.0"  
Weight: 39oz  
Recovery: 36" Nylon Chute  
Motor Mount: 38mm  
Fins: 3 - 1/4" Plywood  
CG: 38" from nose tip

## Parts List

- (1) Nose Cone
- (1) Pre-slotted aft body tube (19")
- (1) Forward body tube (19")
- (1) Coupler
- (2) Centering rings
- (1) 38mm Motor tube
- (3) laser-cut fins
- (1) Eyebolt, nut and washer
- (1) Nylon shock cord
- (2) Rail buttons (2) screws
- (1) Cut Vinyl Letter Decal
- (1) 12x12 Chute Protector (optional)
- (1) 36" Nylon chute (optional)

## You'll need these items to complete this kit

- 5 Minute Epoxy
- Filler and Paint
- Zap or CA Super Glue
- Motor Retainer
- Pencil
- 120/220 Sandpaper

K-131



8 98666 00131 4

**madcow Rocketry**  
put some fun in your rockets!

Please make sure you read all directions and understand how to assemble your model before you start construction. It is also a good idea to test fit each part before assembly – some manufacturing tolerances may require light sanding before final assembly.

Laser cut parts will exhibit varying amounts of charring on the edges depending on the density of the plywood. The charred edges do not interfere with bonding and do not need to be cleaned before assembly. In most cases the charring will be cleaned up during sanding for finishing and painting.

## Motor Mount Assembly

- Step 1 - Sand the glassine coating off of the motor tube. Epoxy will not stick very well to the glassine and roughing the tube will help the epoxy stick.
- Step 2 - Test fit the centering rings over the motor mount tube and sand if necessary. The ring should slide snug over the motor tube without deforming it. Also test fit the centering rings in the body tube and sand if necessary.
- Step 3 - One of the rings will have a hole for an eyebolt to attach the shock cord - this will be the forward ring. Spread some epoxy on the outside of one end of the motor tube and slide the forward ring (with the extra hole) until there is approximately 1/2" of motor tube exposed.

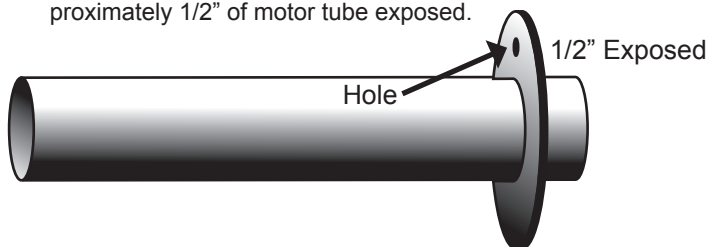

- Step 4 - After the forward ring is dry, spread some epoxy on the other side of the motor tube and slide the aft ring until there is 1/2" exposed on the aft end of the motor tube. **VERY IMPORTANT: make sure there is not any epoxy on the motor tube between the 2 rings that would interfere with the fin tangs later on.**

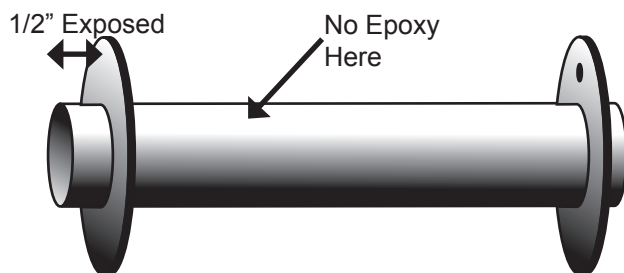

- Step 5 - Mount the eyebolt using the nut and washer in the forward ring hole. Apply some epoxy to the threads of the eyebolt and nut to ensure it will not come loose later. Make sure the eyebolt is aligned so that it will not interfere with the body tube when the motor assembly is inserted into the body tube later.

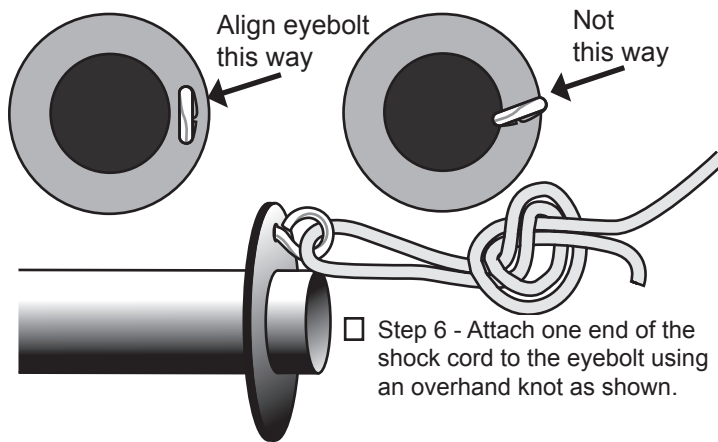
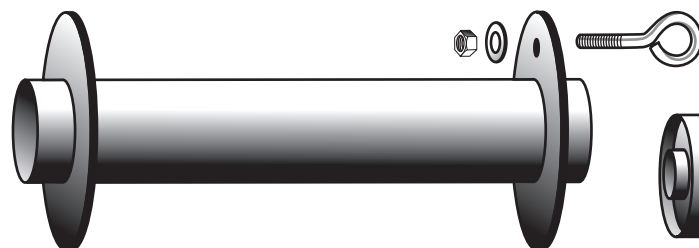

- Step 6 - Attach one end of the shock cord to the eyebolt using an overhand knot as shown.

## Body Tube Assembly

- Step 7 - Wrap the shock chord into a small bundle and stuff it inside the motor tube for this next step. Test fit the motor tube assembly into the aft end (end closest to the slots) of the body tube to ensure a snug fit. Sand the centering rings if necessary.
- Step 8 - When you are satisfied with the fit, spread some epoxy on the inside of the body tube about 5" from the aft end and slide the forward centering ring of the motor assembly into the body tube. **Make sure you have the motor assembly facing the right way - the centering ring with the eyebolt should slide in first!**

Keep going by spreading some more epoxy on the inside of the body tube near the aft edge before sliding the aft centering ring into the body tube. Continue sliding the assembly inside the body tube until the aft centering ring is all the way in body tube. It's a good idea to test fit a fin in each slot here before the epoxy sets. Hold the body tube with the motor tube assembly down until the epoxy sets. Make sure the weight of the motor assembly doesn't cause it to slide out of alignment.

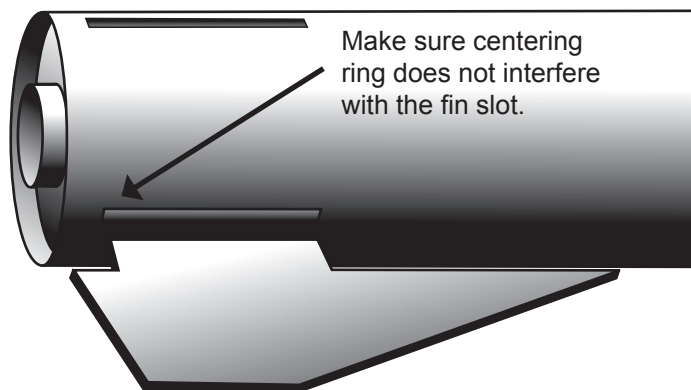

- Step 9 - After this assembly has dried, join the two body tubes together. Spread epoxy on the inside ends of both tubes to be joined and slide the coupler 1/2 into each tube. Ensure the coupler doesn't slide farther into one tube than the other when joining the tubes. Press the tubes together and make sure they stay in alignment while the epoxy sets.



## Fin Assembly

- Step 10 - Using a door jam or small section of angle stock, pencil a line halfway between two of the fin slots on the main body tube that extends from the front to the back of the body tube.

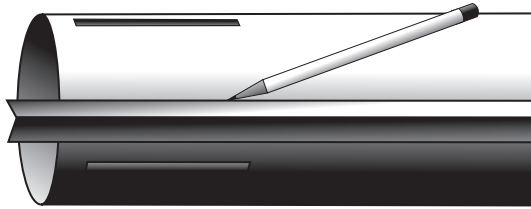

- Step 11 - Test fit each of the fins into the pre cut fin slots. The fin should seat firmly against the motor tube - sand each fin if necessary. When you are satisfied with the fit, apply some epoxy to the end of the fin tang that will contact the motor tube as well as any fin root that will contact the body tube. Also, spread a thin layer of epoxy on each side of the fin tang.

Slide the fin into place and check the alignment. Continue rechecking the fin alignment until you are sure the epoxy has set. Clean any excess epoxy from around the fin joint. Repeat for the remaining fins.

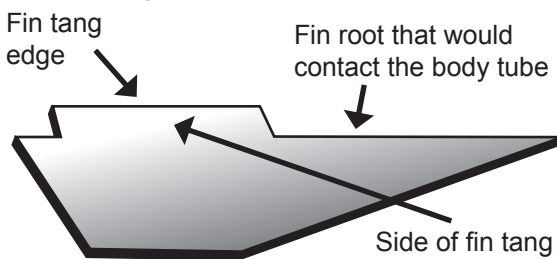

- Step 14 - Next, apply epoxy fillets to both sides of each fin. Carefully smooth the epoxy fillets with your finger before the epoxy sets. Allow each fillet to set before rotating the airframe for the next fillet.

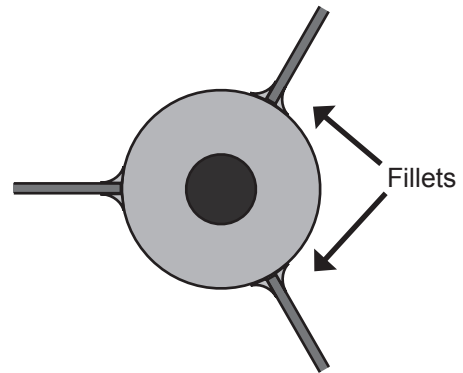

- Step 15 - It is also a good idea to CA the sharp tips of the fins to keep them from splintering on hard landings.

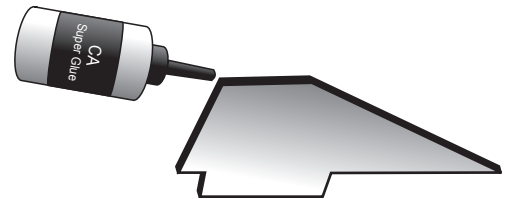

## Final Assembly

- Step 16 - Test fit the nose cone into the body tube. If the fit is too snug, you can sand the ridges on the nose cone with 220 sandpaper until the fit is snug but not too tight. If the fit is too loose, you can wrap masking tape around the nose cone shoulder until the fit is correct.

A good rule of thumb is; you should be able to lift the rocket by the nose cone vertically without the nose cone coming out of the body tube. However, with a little shaking, the body tube should drop away from the nose cone.

**A WORD ABOUT PLASTIC NOSE CONES:** All plastic nose cones expand and contract with heat and cold. A nose cone that fits correctly at room temperature when moved to a desert heat of 120°F may become so tight that it cannot be removed. Likewise, a nose cone moved from room temperature to a snow covered flying field of 25°F may become so loose that it drag separates at motor burnout. It is always a good idea to adjust your nose cone fit on the flying field at the temperature you expect to fly in.

## Rail Button Attachment

- Step 12 - Drill a 5/64" hole on the rail button line for the forward and aft rail buttons. The aft hole can go into the aft centering ring. The forward hole should go into the forward centering ring.
- Step 13 - Apply a small amount of epoxy in the holes and attach the rail buttons using the supplied #6 wood screws. Make sure the screw is loose enough for the rail button to spin freely - this ensures the button is not compressed to the point it will hang on the rail guide. Site down the rail buttons from the aft end of the rocket to ensure the rail buttons are in alignment.

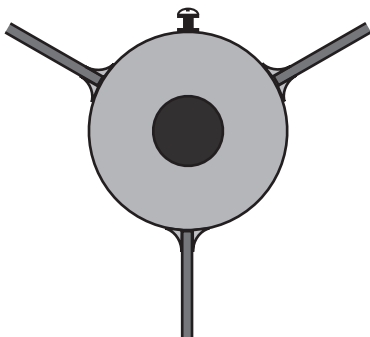

- Step 17 - Using the same knot you used in step 6, attach the other end of the shock cord to the nose cone.
- Step 18 - Attach the parachute to the shock cord near the nose cone. Also attach the chute protector to the shock cord near the nose cone.
- Step 19 - Drill a small 1/8" hold in the chute compartment to allow venting. Make sure you do this without the chute in the chute compartment.
- Step 20 - At this point install your positive motor retention device. The kit does not include a motor retention device and this will need to be purchased separately.

## Balancing Your Model

- Step 21 - Pack the chute and assemble the rocket. When packing your chute, wrap the chute protector around the chute with the opening in the chute protector facing forward. Always make sure your chute is well protected as the hot ejection motor gasses will melt the nylon chute.
- Step 22 - Insert the largest motor that you intend to fly (or simulate the weight with an appropriate substitute) and ensure that the CG (where the rocket balances front to back) is at or in front of the point defined in the specifications on the first page. The CG should be measured from the tip of the nose cone.  
**IMPORTANT: Screw in several screws through the plastic nose cone into the lead to hold it in place. Grind or cut off the screw head before filling and applying the nose cone finish. The epoxy will not stick to the inside of the nose cone and if you do not anchor with screws, the liftoff force will cause the weight to become dislodged causing an unstable model.**
- Step 23 - If the CG is behind the specified point, add weight inside the nose cone by pouring lead shot into the nose cone and adding some epoxy. Hold the nose cone with the tip down so the weight will be as far forward as possible.
- Step 24 - Your model is now ready to paint and apply the decal. To apply the cut lettering decal, carefully remove the backing from the decal - the individual letters will remain stuck to the top carrier. Next, position the decal where you would like it and carefully smooth out the top carrier to ensure the letters are securely attached to the rocket body. Last, carefully remove the top carrier making sure the letters stay attached to the rocket body and are not lifted with the carrier.

At this point your model is ready to fly.

Now go have some fun!

## Flying Your Model

**IMPORTANT: always use positive motor retention to secure the motor. Failure to use motor retention will cause the motor to be ejected instead of the parachute making for a dangerous ballistic reentry.**

**IMPORTANT: always remember to check your balance point and ensure your CG is forward of the specified CG point.**

**IMPORTANT: Always follow the NAR safety code and remember that rockets are not toys and can be dangerous if not prepared and used properly. If you are a beginner, it is a good idea to fly with a club or other group of experienced rocketeers until you have gained some experience.**

**IMPORTANT: In no event shall Madcow Rocketry be liable for any direct, indirect, punitive, incidental, special consequential damages whatsoever arising out of or connected with the use or misuse of its products. The buyer assumes all risk and liability resulting from ANY use of any and all products sold by Madcow Rocketry. Your purchase and use of any Madcow Rocketry product constitutes your agreement to and acceptance of these terms. If you do not agree to these terms and conditions, you must return the unused product in resalable condition for a refund or credit.**

**IMPORTANT: Please contact us via phone or email if you have any questions about constructing or flying your model.**



24338 El Toro Rd #E-134

Laguna Woods, CA 92637

949.547.8847

[www.madcowrocketry.com](http://www.madcowrocketry.com)

[support@madcowrocketry.com](mailto:support@madcowrocketry.com)

©2009 MadCow Rocketry™