





Model Rocket Safety Code

- 1. Materials.** I will use only lightweight, non-metal parts for the nose, body, and fins of my rocket.
- 2. Motors.** I will use only certified, commercially-made model rocket motors, and will not tamper with these motors or use them for any purposes except those recommended by the manufacturer.
- 3. Ignition System.** I will launch my rockets with an electrical launch system and electrical motor igniters. My launch system will have a safety interlock in series with the launch switch, and will use a launch switch that returns to the "off" position when released.
- 4. Misfires.** If my rocket does not launch when I press the button of my electrical launch system, I will remove the launcher's safety interlock or disconnect its battery, and will wait 60 seconds after the last launch attempt before allowing anyone to approach the rocket.
- 5. Launch Safety.** I will use a countdown before launch, and will ensure that everyone is paying attention and is a safe distance of at least 15 feet away when I launch rockets with D motors or smaller, and 30 feet when I launch larger rockets. If I am uncertain about the safety or stability of an untested rocket, I will check the stability before flight and will fly it only after warning spectators and clearing them away to a safe distance.
- 6. Launcher.** I will launch my rocket from a launch rod, tower, or rail that is pointed to within 30 degrees of the vertical to ensure that the rocket flies nearly straight up, and I will use a blast deflector to prevent the motor's exhaust from hitting the ground. To prevent accidental eye injury, I will place launchers so that the end of the launch rod is above eye level or will cap the end of the rod when it is not in use.
- 7. Size.** My model rocket will not weigh more than 1,500 grams (53 ounces) at liftoff and will not contain more than 125 grams (4.4 ounces) of propellant or 320 N-sec (71.9 pound-seconds) of total impulse. If my model rocket weighs more than one pound (453 grams) at liftoff or has more than four ounces (113 grams) of propellant, I will check and comply with Federal Aviation Administration regulations before flying.
- 8. Flight Safety.** I will not launch my rocket at targets, into clouds, or near airplanes, and will not put any flammable or explosive payload in my rocket.
- 9. Launch Site.** I will launch my rocket outdoors, in an open area at least as large as shown in the accompanying table, and in safe weather conditions with wind speeds no greater than 20 miles per hour. I will ensure that there is no dry grass close to the launch pad, and that the launch site does not present risk of grass fires.
- 10. Recovery System.** I will use a recovery system such as a streamer or parachute in my rocket so that it returns safely and undamaged and can be flown again, and I will use only flame-resistant or fireproof recovery system wadding in my rocket.
- 11. Recovery Safety.** I will not attempt to recover my rocket from power lines, tall trees, or other dangerous places.

LAUNCH SITE DIMENSIONS

Installed Total Impulse (N-sec)	Equivalent Motor Type	Minimum Site Dimensions (ft.)
0.00 — 1.25	1/4A	50
1.26 — 2.50	A	100
2.51 — 5.00	B	200
5.01 — 10.00	C	400
10.01 — 20.00	D	500
20.01 — 40.00	E	1000
40.01 — 80.00	F	1000
80.01 — 160.00	G	1000
160.01 — 320.00	2 Gs	1500





RUSKIE

EASY TO BUILD AND FLY

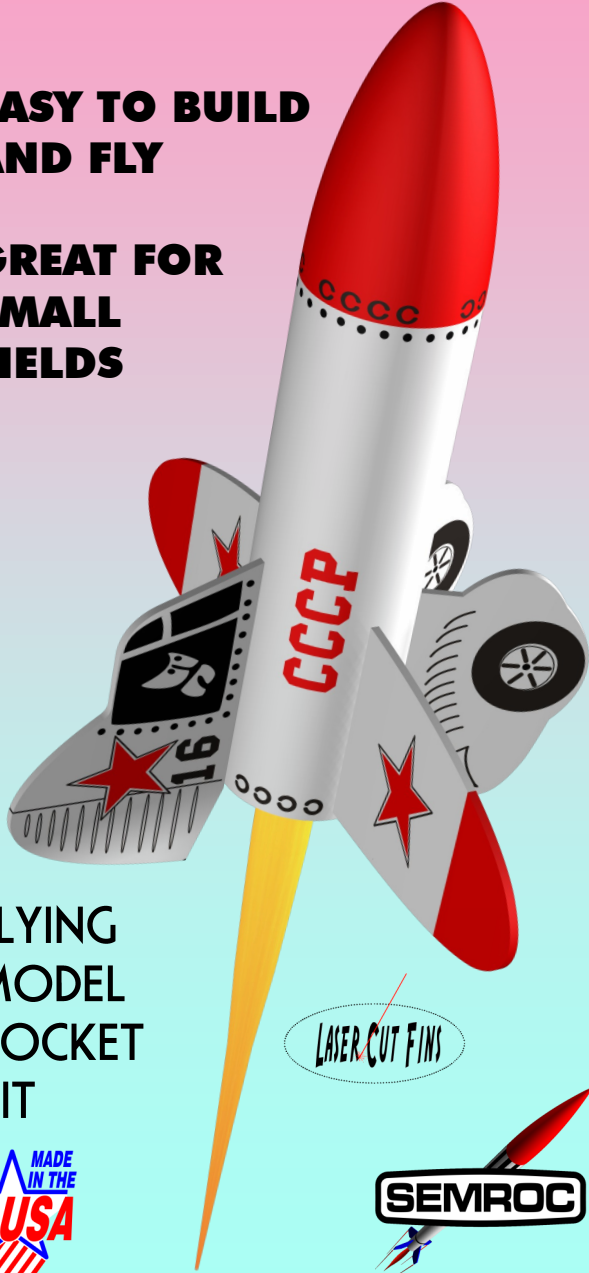

GREAT FOR SMALL FIELDS

FLYING MODEL ROCKET KIT



LAZER-CUT FINS



Made in the U.S.A by Semroc Astronautics Corporation - Knightdale, N.C. 27545

Ruskie™
Kit No. KA-11

	Specifications	Engine	Approx. Altitude
Body Diameter	1.84" (4.7 cm)	A8-3	125'
Length	9.8" (24.9 cm)	B6-4	300'
Fin Span	8.3" (21.1 cm)	C6-5	725'
Net Weight	1.8 oz. (50.1 g)		

PARACHUTE RECOVERY

ABOUT THE GROONIES™

In 1973, Estes® Industries introduced a new line of six of "the zaniest flying freaks in the universe" called the Goonybirds. Wayne Kellner has been attributed as the primary creator of the line. All six kits featured a plastic nose cone, die-cut fins, quick-change mini-engine mount, parachute recovery, stick-on decals, and, of course, a unique, goofy design. Although they only had a two year run in production, they have been re-created by many as a tribute to the original designs. Fred Talasco, of www.excelsiorrocketry.com, has kept the "Get Goony" concept alive in his very creative line.

Bill Simon, Vice President of Estes® Industries during its formative years, recently posted some original sketches of early ideas for the Goonybirds on a rocketry forum. They were even more exciting than the original offering; more military, more "Mad Magazine," more "grown-up." That led to the Semroc Groonies™: Goonybirds that grew up. If they really "grew up," not only would they need more grown-up themes, they would also have to be slightly bigger to fly reliably with available standard size engines, since the original mini-engine line selection has been reduced over the years. Returning to balsa nose cones and waterslide decals, along with upgrading to laser-cut balsa fins and Kevlar® shock cord mounts has improved the original line to make it even better.

About Semroc Astronautics Corporation

Semroc Astronautics Corporation was started by Carl McLawhorn in his college dorm at North Carolina State University in November, 1967. Convincing a small group of investors in his home town of Ayden, North Carolina to invest in a small corporation, the company was re-incorporated as Semroc Astronautics Corporation on December 31, 1969.

Semroc produced a full line of model rocket kits and engines. At its peak, Semroc had twenty-five full time employees working at two facilities. One was for research and development, printing, shipping, and administration. The other was outside town and handled all production and model rocket engine manufacturing. For several years, Semroc was successful selling model rocket kits, supplies, and engines by mail-order and in hobby shops. In early 1971, Semroc became insolvent and had to close its doors.

After 31 years of dreams and preparations, Semroc Astronautics Corporation was reincorporated on April 2, 2002 with a strong commitment to helping put the fun back into model rocketry.

December 19, 2007

Copyright © 2007 Semroc Astronautics Corporation
Box 1271 Knightdale, NC 27545 (919) 266-1977

LIMITATION OF LIABILITY

Model rockets are not toys, but are functional rockets made of lightweight materials and are launched with NAR or Tripoli safety certified model rocket engines, electrically ignited and flown in accordance with the NAR Model Rocket Safety Code. If misused, model rockets can cause serious injury and property damage. Semroc certifies that it has exercised reasonable diligence in the design and manufacture of its products. Semroc cannot assume any liability for the storage, transportation, or usage of its products. Semroc shall not be held responsible for any personal injury or property damage whatsoever arising out of the handling, storage, use, or misuse of our products. The buyer assumes all risks and liabilities therefrom and accepts and uses Semroc products on these conditions.

Your purchase and use of any Semroc products is construed as your agreement to and acceptance of these terms. If you do not agree to these terms and conditions, you must return the product, unused, for refund or credit.

100% SATISFACTION GUARANTEE

If you are not 100% satisfied with your Semroc product, we will make it right by providing whatever you consider fair, from refund to replacement.

Contact us at:

Semroc Astronautics Corporation
Customer Service Department
P.O. Box 1271
Knightdale, North Carolina 27545

JOIN THE NAR!

Sign up online at www.nar.org to join the premier model rocketry organization. Semroc fully supports the National Association of Rocketry and recognizes it as the sport's official voice. The NAR is the oldest and largest sport rocketry organization in the world. Since 1957 over 80,000 serious sport rocket modelers have joined the NAR to take advantage of the fun and excitement of organized rocketry. It is always more fun if you fly with friends. The *Sport Rocketry* magazine is one of the best ways to keep informed of new developments in the hobby. Check online at www.semroc.com/nar for promotions just for NAR members.



- ❑ **30.** After the paint has dried, decals should be applied. The decals supplied with the Ruskie™ are waterslide decals. Apply each decal before starting the next. Check for fit before wetting the decal. A drop of detergent in the water will allow for more movement before the decal sets.

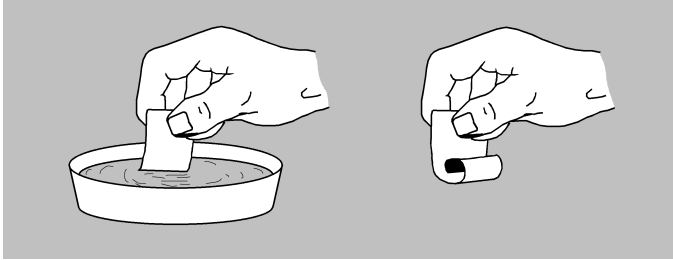

FLIGHT PREPPING

- ❑ **31.** Mounting the engine: Insert the engine and make sure the engine hook keeps the engine in snugly. The hook may be slightly bent to make sure the engine is retained.
- ❑ **32.** Pack the recovery wadding from the top of the body tube. Use a sufficient quantity to protect the parachute, but not too much that there is no room left. There is not much room left after sufficient wadding is applied.
- ❑ **33.** Fold the parachute and pack it and the shock cord on top of the recovery wadding. Slide the nose cone into place, making sure it does not pinch the shock cord or parachute.
- ❑ **34.** Refer to the model rocket engine manufacturer's instructions to complete the engine prepping. Different engines have different igniters and methods of hooking them up to the launch controllers.
- ❑ **35.** Carefully check all parts of your rocket before each flight as a part of your pre-flight checklist. Launch the Ruskie™ from a 1/8" diameter by 36" long launch rod.

About the Ruskie™

The Ruskie™ is the second of the Semroc Groonies™ to be released. It is an upscale of the basic design of the Estes® Zoom Broom that was released in 1973 as one of their Goonybirds. The original working drawing was for a Russian Interceptor. Perhaps because we were trying to end the Cold War and make friends with the Russians, the final design became a witch flying a rocket shaped broom since we did not have the same sensitivities to witches!

In any case, the Semroc Ruskie has returned to the original Cold Warrior looking for some stray American fighters that might "accidentally" fly into Russian airspace. The Ruskie will fly on all size fields and will be a great addition to your collection of Groonies!

BEFORE YOU START!

Make sure you have all the parts included in this kit that are listed in the Parts List in the center of these instructions. In addition to the parts included in this kit, you will also need the tools and materials listed below. Read the entire instructions before beginning to assemble your rocket. When you are thoroughly familiar with these instructions, begin construction. Read each step and study the accompanying drawings. Check off each step as it is completed. In each step, test-fit the parts together before applying any glue. It is sometimes necessary to sand lightly or build-up some parts to obtain a precision fit. If you are uncertain of the location of some parts, refer to the exploded view in the center of these instructions. It is important that you always ensure that you have adequate glue joints.

TOOLS: In addition to the parts supplied, you will need the following tools to assemble and finish this kit. Masking tape is also needed.

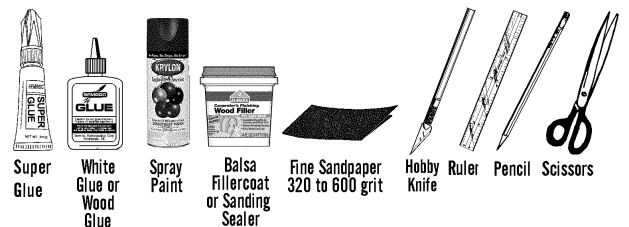

ASSEMBLY

- 1.** These instructions are presented in a logical order to help you put your Ruskie™ together quickly and efficiently. Check off each step as you complete it and enjoy putting this kit together.

PREPARE NOSE CONE

- 2.** Twist the screw eye into the center of the plywood disc. Only screw it in until the threads just disappear into the plywood. Apply glue to the thread side and set this assembly aside to dry.

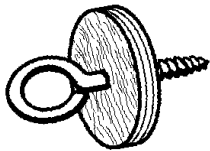

- 3.** Roll the clay weight into a cylinder about 5/8" in diameter. Insert into the drilled hole in the nose cone.

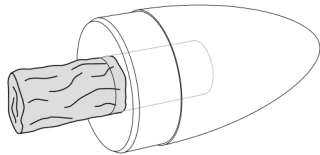

- 4.** Using a wood dowel, pencil eraser, or your finger, push the clay weight as far into the nose cone as possible.

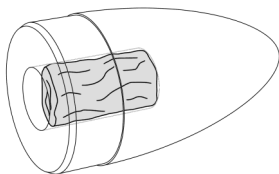

- 5.** Insert the plywood disc and screw eye assembly into the hole in the nose cone and press it firmly against the clay weight.

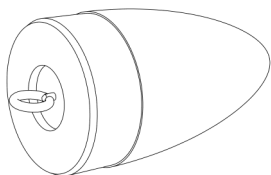

- 6.** Make sure there is no clay showing. **The glue will not stick to the clay.** Apply a glue fillet around the plywood disc-nose cone joint. Leave the nose cone in a vertical position with the screw eye facing upwards until the glue is completely dry.

FINISHING

- 27.** When the fillets have dried, prepare balsa surfaces for a smooth professional looking finish. Fill the wood grain with Fill 'n' Finish, balsa filler-coat or sanding sealer. When dry, sand with fine sandpaper. Repeat until smooth.

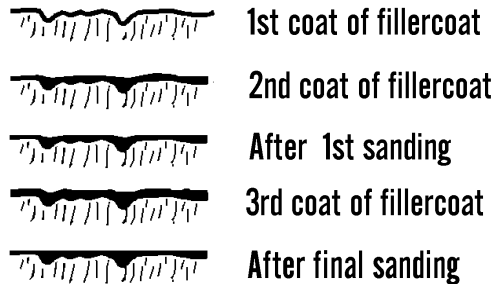

- 28.** After all balsa surfaces have been prepared, wipe off all balsa dust with a dry cloth. First spray the model with an enamel primer, then spray a base color of gloss white. Spray a final coat of bright red on the nose cone and wing tips.

- 29.** Spray painting your model with a fast-drying enamel will produce the best results. **PATIENCE...** is the most important ingredient. Use several thin coats, allowing each coat to completely dry before the next coat. Start each spray a few inches above the model and end a few inches below the model. Keep the can about 12" away and use quick light coats. The final coat can be a little heavier to give the model a glossy wet-looking finish.

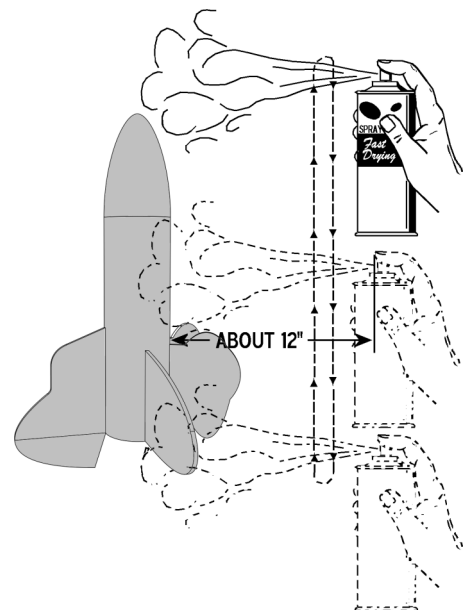

FINAL ASSEMBLY

- ❑ **25.** Assemble chute using instructions printed on the canopy. Attach chute by passing the lines through the screw eye and looping them over the tip of the nose cone as shown. Pull the lines tight and make sure they are all of equal length. Put a drop of glue on the joint to keep the lines from moving.

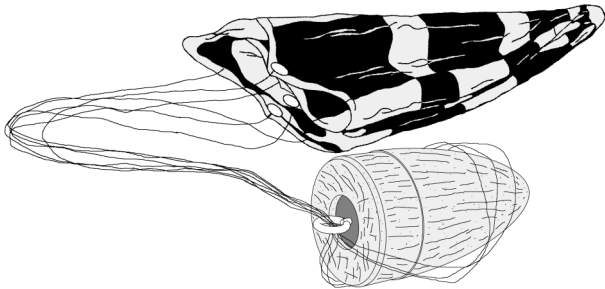

- ❑ **26.** Pull the Kevlar® thread out of the top of the main body tube. Tie the loose end to one end of the elastic cord. Tie the other end of the elastic cord to the screw eye. Put a drop of glue on both knots to keep them from untying.

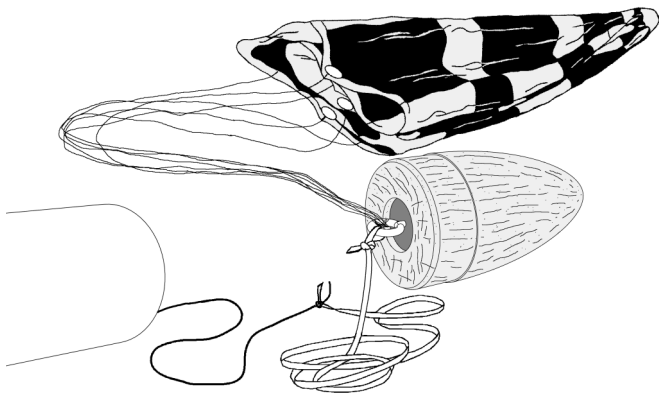

This completes the assembly of your

RUSKIE

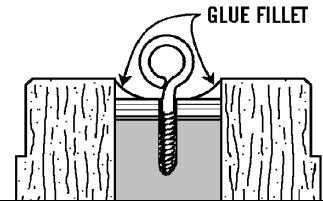

ENGINE MOUNT

- ❑ **7.** Bend the engine hook slightly so it forms a slight bow in the direction shown.

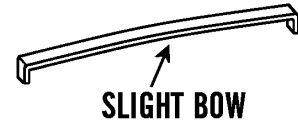

- ❑ **8.** Tie a loop in one end of the yellow Kevlar® cord. Insert one end of the engine hook through the loop and into the pre-punched engine tube.

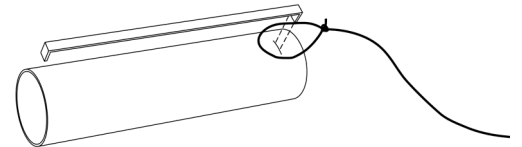

- ❑ **9.** Apply a bead of glue inside the top of the engine tube. Glue the thrust ring in place on top of the engine hook as shown.

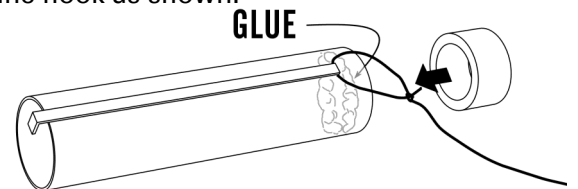

- ❑ **10.** Slide the centering ring without the notch over the engine tube until it is about 1" from the top end. Apply a bead of glue around the joint on both sides. Place the Kevlar cord into the top of the tube and pull it through as shown.

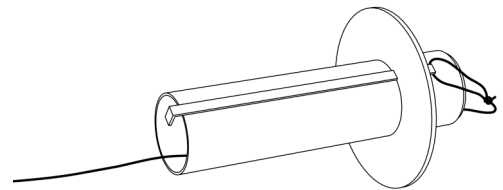

- ❑ **11.** Wrap a layer of masking tape around the engine tube near the middle. Apply a coating of glue over the tape around the engine hook area.

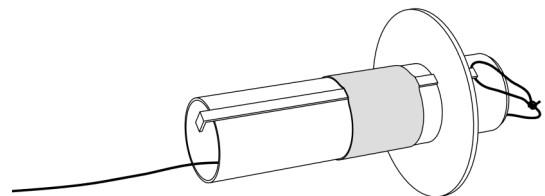

- ❑ **12.** Slide the remaining centering ring over the end of the tube aligning the engine hook with the slot. Center it about 1/8" from the end and apply a bead of glue around both sides of the ring at the joint. Allow to dry.

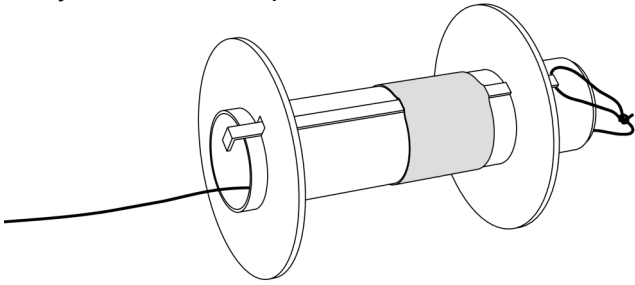

- ❑ **13.** Mark a line inside the large body tube at a depth of 3/4". Apply a bead of glue around the inside of the tube at about the depth of the mark.

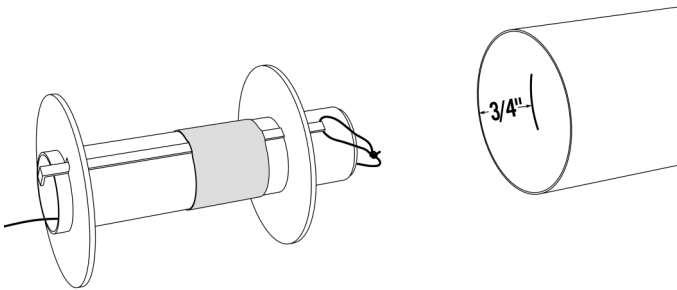

- ❑ **14.** In one quick motion, slide the engine mount into the large body tube until the pencil mark just shows. Apply a bead of glue around the bottom joint. As that joint sets, apply an additional bead of glue on the top of the mount from the top of the large tube. Spread a thin film of cyanoacrylate glue (CA) around the inside area of the large body tube to help it resist the exhaust heat. Allow to dry.

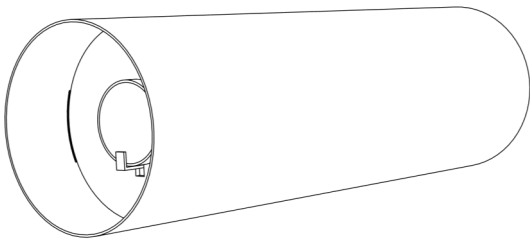

MARK TUBE

- ❑ **15.** Stand the large body tube on the fin guide at the top of the next page. Mark the fin and launch lug positions on the side of the tube. Find a convenient channel or groove such as a partially open drawer, a door jamb (as shown), or a piece of molding. Using the channel, extend the marks the full length of the large body tube.

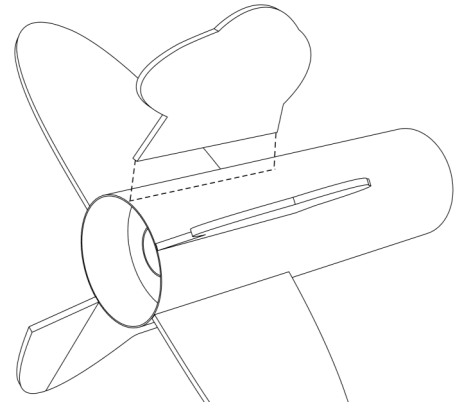

LAUNCH LUG

- ❑ **23.** Attach the launch lug on the bottom of the rocket along the LL line marked. Make sure the end of the launch lug is even with the end of the main body tube.

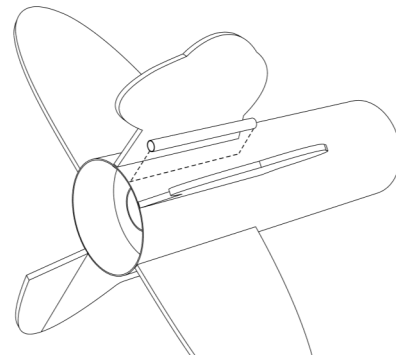

SHOCK CORD

- ❑ **24.** Pull the Kevlar cord out of the top of the large body tube. Line up one end of the elastic shock cord with the free end of the Kevlar cord, and tie an overhand knot at the end of the two cords. Pull the knot tight and place a small drop of white glue on the knot to prevent it from loosening.

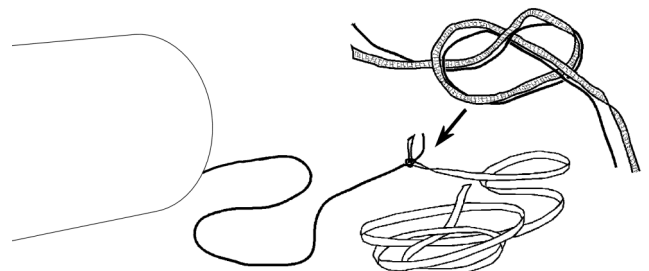

- ❑ **19.** Glue the two parts of the rudder and cockpit together and allow to dry.

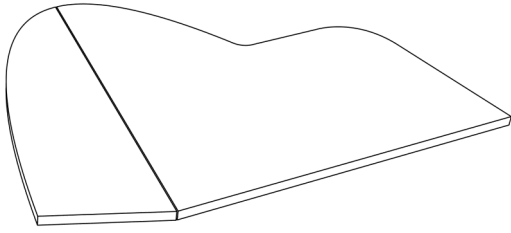

FIN ATTACHMENT

- ❑ **20.** Glue the rudder and cockpit assembly to the large body tube on the rudder line. Make sure the engine mount is on the fin attachment end as shown below! Apply fillets to the joint and allow to dry.

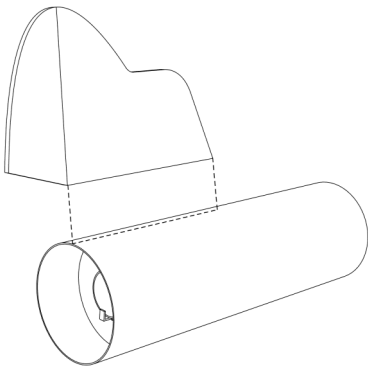

- ❑ **21.** Attach the two main wings on the wing lines. Apply fillets to each joint and set the assembly aside to dry.

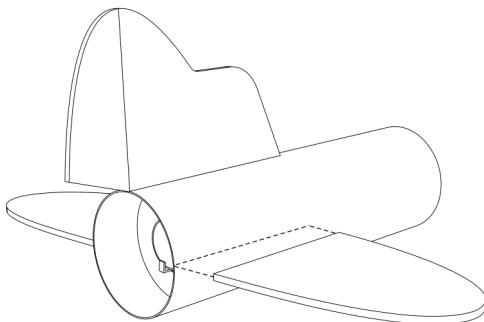

- ❑ **22.** Attach the two wheel fins on the bottom of the body tube on the wheel lines.

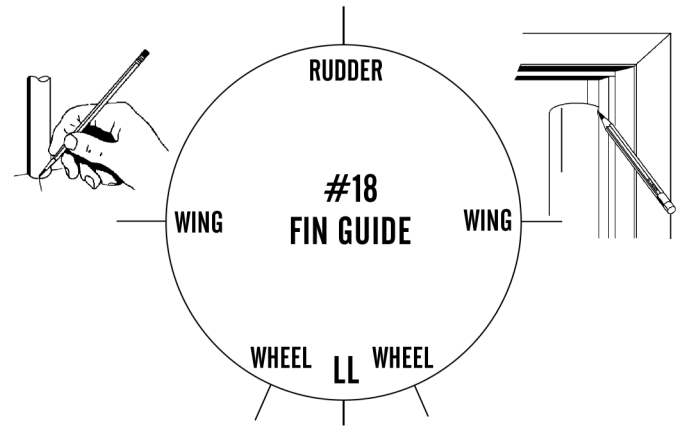

FIN PREPARATION

- ❑ **16.** Lightly sand each side of the laser-cut fins. Carefully push the laser-cut fins from their sheet. Start at one point on each fin and slowly and gently work around the fin.

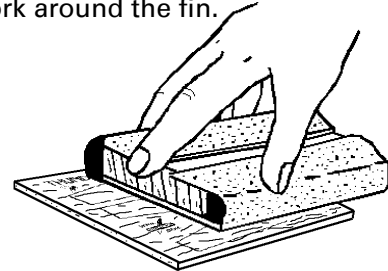

- ❑ **17.** Stack the sets of similar fins in groups and line them up squarely. Run each set of fins back and forth over some fine sandpaper to get rid of the hold-in tabs as shown below.

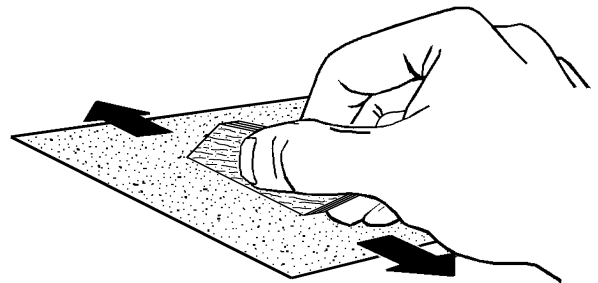

- ❑ **18.** If you prefer, round the leading and trailing edges of the fins. The root edges will be glued to the body tube.

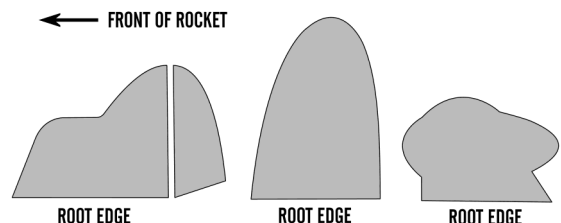

Parts List

A	1	Balsa Nose Cone	BC-1828D
B	1	Body Tube	ST-1860
C	1	Body Tube	ST-730E
D	1	Centering Ring Set	CR-KV-11
E	1	Laser-cut Fin Set	FV-11
F	1	Thrust Ring	TR-7
G	1	Elastic Cord	EC-118
H	1	Kevlar Thread	SCK-12
I	1	Screw Eye	SE-12
J	1	Launch Lug	LL-122
K	1	Engine Hook	EH-28
L	1	Plywood Block	PB-75
M	1	Clay Weight	WC-5
N	1	Plastic Parachute	RC-12
O	1	Tape Disc	TD-6
P	1	Shroud Line	SLT-6
Q	1	Decal	DKA-11

EXPLODED VIEW

