



Model Rocket Safety Code

- 1. Materials.** I will use only lightweight, non-metal parts for the nose, body, and fins of my rocket.
- 2. Motors.** I will use only certified, commercially-made model rocket motors, and will not tamper with these motors or use them for any purposes except those recommended by the manufacturer.
- 3. Ignition System.** I will launch my rockets with an electrical launch system and electrical motor igniters. My launch system will have a safety interlock in series with the launch switch, and will use a launch switch that returns to the "off" position when released.
- 4. Misfires.** If my rocket does not launch when I press the button of my electrical launch system, I will remove the launcher's safety interlock or disconnect its battery, and will wait 60 seconds after the last launch attempt before allowing anyone to approach the rocket.
- 5. Launch Safety.** I will use a countdown before launch, and will ensure that everyone is paying attention and is a safe distance of at least 15 feet away when I launch rockets with D motors or smaller, and 30 feet when I launch larger rockets. If I am uncertain about the safety or stability of an untested rocket, I will check the stability before flight and will fly it only after warning spectators and clearing them away to a safe distance.
- 6. Launcher.** I will launch my rocket from a launch rod, tower, or rail that is pointed to within 30 degrees of the vertical to ensure that the rocket flies nearly straight up, and I will use a blast deflector to prevent the motor's exhaust from hitting the ground. To prevent accidental eye injury, I will place launchers so that the end of the launch rod is above eye level or will cap the end of the rod when it is not in use.
- 7. Size.** My model rocket will not weigh more than 1,500 grams (53 ounces) at liftoff and will not contain more than 125 grams (4.4 ounces) of propellant or 320 N-sec (71.9 pound-seconds) of total impulse. If my model rocket weighs more than one pound (453 grams) at liftoff or has more than four ounces (113 grams) of propellant, I will check and comply with Federal Aviation Administration regulations before flying.
- 8. Flight Safety.** I will not launch my rocket at targets, into clouds, or near airplanes, and will not put any flammable or explosive payload in my rocket.
- 9. Launch Site.** I will launch my rocket outdoors, in an open area at least as large as shown in the accompanying table, and in safe weather conditions with wind speeds no greater than 20 miles per hour. I will ensure that there is no dry grass close to the launch pad, and that the launch site does not present risk of grass fires.
- 10. Recovery System.** I will use a recovery system such as a streamer or parachute in my rocket so that it returns safely and undamaged and can be flown again, and I will use only flame-resistant or fireproof recovery system wadding in my rocket.
- 11. Recovery Safety.** I will not attempt to recover my rocket from power lines, tall trees, or other dangerous places.

LAUNCH SITE DIMENSIONS

Installed Total Impulse (N-sec)	Equivalent Motor Type	Minimum Site Dimensions (ft.)
0.00 — 1.25	1/4A	50
1.26 — 2.50	A	100
2.51 — 5.00	B	200
5.01 — 10.00	C	400
10.01 — 20.00	D	500
20.01 — 40.00	E	1000
40.01 — 80.00	F	1000
80.01 — 160.00	G	1000
160.01 — 320.00	2 Gs	1500

Astro-Jr™

MINI SPORT FLYING ROCKET

GREAT BEGINNER KIT

EASY & FAST TO BUILD

SMALL FIELDS

FLYING MODEL ROCKET KIT

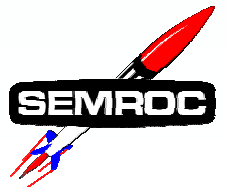

Made in the U.S.A by Semroc Astronautics Corporation - Knightdale, N.C. 27545

ASTRO - JR Kit No. KA-4

Specifications	Engine	Approx. Altitude	
Body Diameter	0.908" (2.3 cm)	1/2 A3-4T	200'
Length	14.9" (37.8 cm)	A3-4T	450'
Fin Span	4.1" (10.4 cm)	A10-4T	450'
Net Weight	0.7 oz. (20.1 g)		

PARACHUTE RECOVERY

About Semroc Astronautics Corporation

Semroc Astronautics Corporation was started by Carl McLawhorn in his college dorm at North Carolina State University in November, 1967. Convincing a small group of investors in his home town of Ayden, North Carolina to invest in a small corporation, the company was re-incorporated as Semroc Astronautics Corporation on December 31, 1969.

Semroc produced a full line of model rocket kits and engines. At its peak, Semroc had twenty-five full time employees working at two facilities. One was for research and development, printing, shipping, and administration. The other was outside town and handled all production and model rocket engine manufacturing. For several years, Semroc was successful selling model rocket kits, supplies, and engines by mail-order and in hobby shops. In early 1971, Semroc became insolvent and had to close its doors.

After 31 years of dreams and preparations, Semroc Astronautics Corporation was reincorporated on April 2, 2002 with a strong commitment to helping put the fun back into model rocketry.

October 20, 2004

Copyright © 2004 Semroc Astronautics Corporation
Box 1271 Knightdale, NC 27545 (919) 266-1977

LIMITATION OF LIABILITY

Model rockets are not toys, but are functional rockets made of lightweight materials and are launched with NAR or Tripoli safety certified model rocket motors, electrically ignited and flown in accordance with the NAR Model Rocket Safety Code. If misused, model rockets can cause serious injury and property damage. Semroc certifies that it has exercised reasonable diligence in the design and manufacture of its products. Semroc cannot assume any liability for the storage, transportation, or usage of its products. Semroc shall not be held responsible for any personal injury or property damage whatsoever arising out of the handling, storage, use, or misuse of our products. The buyer assumes all risks and liabilities therefrom and accepts and uses Semroc products on these conditions.

Your purchase and use of any Semroc products is construed as your agreement to and acceptance of these terms. If you do not agree to these terms and conditions, you must return the product, unused, for refund or credit.

100% SATISFACTION GUARANTEE

If you are not 100% satisfied with your Semroc product, we will make it right by providing whatever you consider fair, from refund to replacement.

Contact us at:

Semroc Astronautics Corporation
Customer Service Department
P.O. Box 1271
Knightdale, North Carolina 27545

JOIN THE NAR!

Sign up online at www.nar.org to join the premier model rocketry organization. Semroc fully supports the National Association of Rocketry and recognizes it as the sport's official voice. The NAR is the oldest and largest sport rocketry organization in the world. Since 1957 over 80,000 serious sport rocket modelers have joined the NAR to take advantage of the fun and excitement of organized rocketry. It is always more fun if you fly with friends. The *Sport Rocketry* magazine is one of the best ways to keep informed of new developments in the hobby. Check online at www.semroc.com/nar for promotions just for NAR members.



FLIGHT PREPPING

- ❑ **24.** Mounting the engine: Insert the engine and make sure the engine hook keeps the engine in snugly. The hook may be slightly bent to make sure the engine is retained.

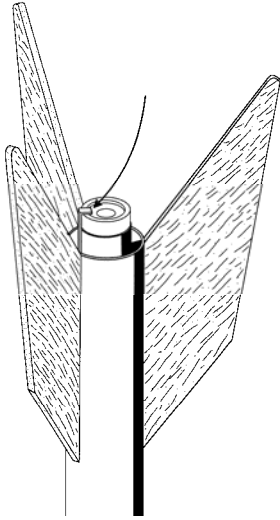

- ❑ **25.** Pack the recovery wadding from the top of the body tube. Use a sufficient quantity to protect the parachute, but not too much that it will interfere with the proper deployment of the parachute.

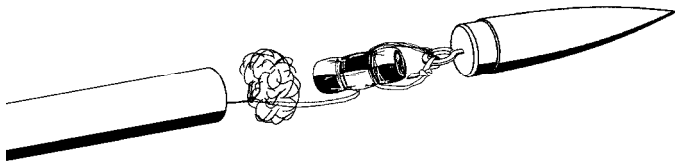

- ❑ **26.** Fold the parachute and pack it and the shock cord on top of the recovery wadding. Slide the nose cone into place, making sure it does not pinch the shock cord or parachute.

- ❑ **27.** Refer to the model rocket engine manufacturer's instructions to complete the engine prepping. Different engines have different igniters and methods of hooking them up to the launch controllers.

- ❑ **28.** Carefully check all parts of your rocket before each flight as a part of your pre-flight checklist. Launch the Astro-Jr from a 1/8" diameter by 36" long launch rod.

About the Astro-Jr™

The Astro-Jr is a smaller scale version of the original Astro-1 by Centuri Engineering Company. The original Astro-1 was released in the 1969 Centuri catalog. It was one of the first model rocket kits to incorporate the "Quick-Change" engine mount that became a standard in model rocketry. Designed to be an excellent beginner's kit, the Astro-1 became the first rocket for thousands of new model rocketeers. The "rake-back" fins were so different that many were built incorrectly with the fins glued on to resemble the Estes Alpha. The Astro-1 was Centuri #KB-17 and was introduced with a price of \$1.75.

The Astro-Jr is designed to use 13mm mini-engines for smaller fields. Altitudes from 200 to 500 feet are possible. The Astro-Jr uses precision laser-cut fins, smooth body tube, and a sanded balsa nose cone to maintain the original look and feel in a slightly smaller package. A 12" multi-colored parachute is included for safe recovery.

BEFORE YOU START!

Make sure you have all the parts included in this kit that are listed in the Parts List in the center of these instructions. In addition to the parts included in this kit, you will also need the tools and materials listed below. Read the entire instructions before beginning to assemble your rocket. When you are thoroughly familiar with these instructions, begin construction. Read each step and study the accompanying drawings. Check off each step as it is completed. In each step, test-fit the parts together before applying any glue. It is sometimes necessary to sand lightly or build-up some parts to obtain a precision fit. If you are uncertain of the location of some parts, refer to the exploded view in the center of these instructions. It is important that you always ensure that you have adequate glue joints.

TOOLS: In addition to the parts supplied, you will need the following tools to assemble and finish this kit.

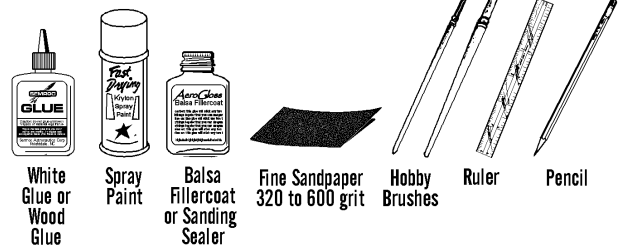

ASSEMBLY

❑ **1.** These instructions are presented in a logical order to help you put your Astro-Jr together quickly and efficiently. Check off each step as you complete it and we hope you enjoy putting this kit together and flying it.

ENGINE MOUNT ASSEMBLY

❑ **2.** Tie a loop in one end of the yellow Kevlar® cord. Insert one end of the engine hook through the loop and into the pre-punched engine tube. Glue the thrust ring in place on top of the engine hook as shown.

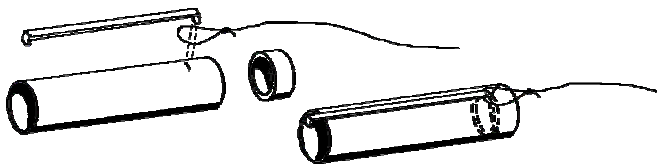

❑ **3.** Glue the two centering rings on the engine mount tube as follows. Slide the first ring from the bottom until it is even with the end of the engine hook. Make sure the yellow Kevlar® cord is free and comes out from the top of the tube as shown below. Mark 3/4" from the bottom of the engine mount tube and slide the other centering ring from the bottom until it is even with the mark.

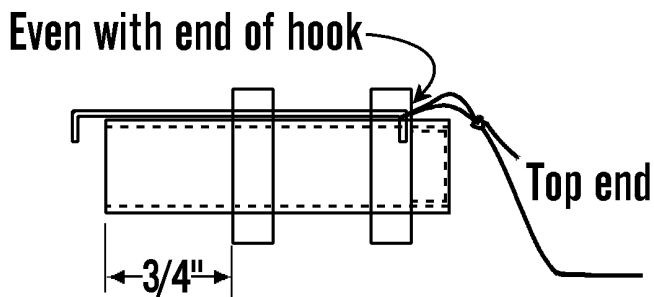

❑ **4.** When centering rings are positioned properly, apply glue fillets around the engine mount tube at all four joints as shown.

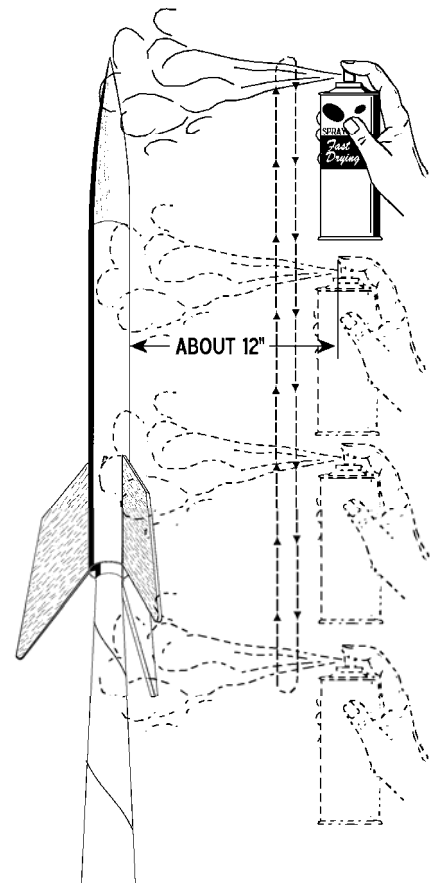

❑ **23.** After the paint has dried, decals should be applied. The decals supplied with the Astro-Jr are waterslide decals. Each decal should be cut separately from the sheet. Completely apply one of the decals before starting the next. Think about where you want to apply each decal and check for fit before wetting the decal. Make sure the ends are aligned with the roll pattern.

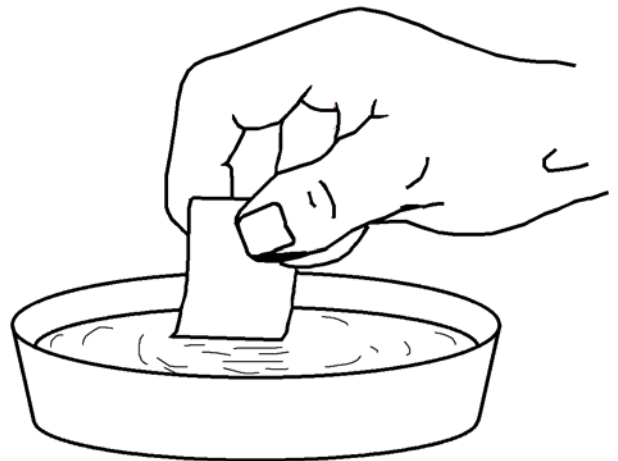

FINISHING

- ❑ **20.** When the fillets have dried, prepare balsa surfaces for a smooth professional looking finish. Fill the wood grain with balsa fillercoat or sanding sealer. When dry, sand with fine sandpaper. Repeat until smooth.

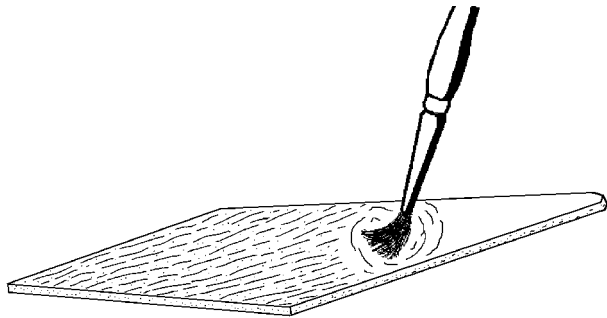

1st coat of fillercoat



2nd coat of fillercoat



After 1st sanding



3rd coat of fillercoat



After final sanding

- ❑ **21.** After all balsa surfaces have been prepared, wipe off all balsa dust with a dry cloth. First spray the model with an enamel primer. Choose a high visibility color combination like white and red for the final color.

- ❑ **22.** Spray painting your model with a fast-drying enamel will produce the best results. PATIENCE...is the most important ingredient. Use several thin coats, allowing each coat to completely dry before the next coat. Start each spray a few inches above the model and end a few inches below the model. Keep the can about 12" away and use quick light coats. The final coat can be a little heavier to give the model a glossy wet-looking finish. Use rolled newspaper to hold the rocket while you spray it.

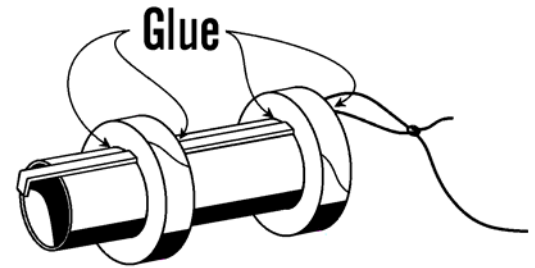

- ❑ **5.** Pull the yellow Kevlar® cord back through the engine mount tube so it will be out of the way later when it is installed in the main body tube. Set the engine mount aside to dry completely.

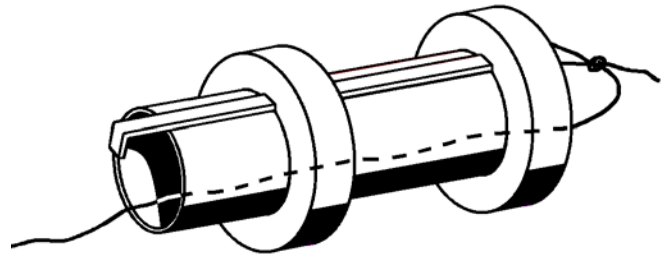

FIN PREPARATION

- ❑ **6.** Lightly sand each side of the laser-cut fins. Carefully push the laser-cut fins from their sheet. Start at one point on each fin and slowly and gently work around the fin.

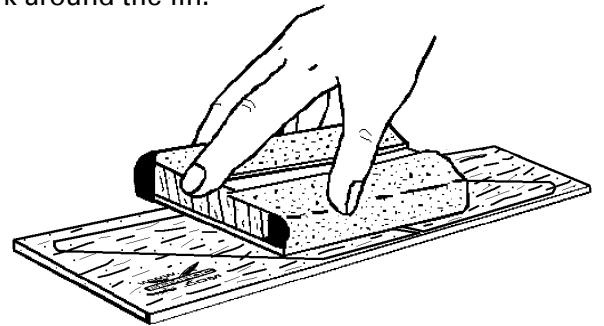

- ❑ **7.** Stack all the fins together. Line them up squarely and sand the fins back and forth over some fine sandpaper to get rid of the hold-in tabs as shown below.



- ❑ **8.** Round all edges except the root edges (which will be glued to the body tube).

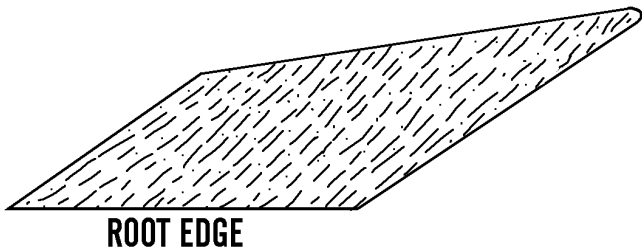

- ❑ **9.** Stand the body tube on the fin guide below and make the fin position marks on the sides of the tube. Find a convenient channel or groove such as a partially open drawer, a door jamb (as shown,) or a piece of molding. Using the channel, extend the marks the full length of the tube to provide lines for aligning the fins.

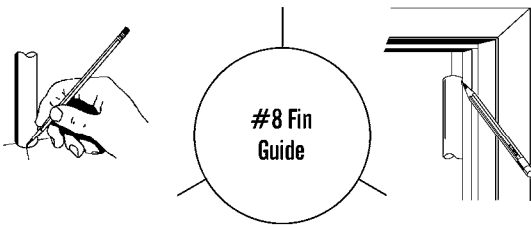

SHOCK CORD

- ❑ **10.** Check the engine mount for fit in the body tube. If it has rough edges or excessive glue, sand lightly until it fits into the body tube. Apply a heavy bead around the inside of the body tube. Then quickly and smoothly push the motor mount into the tube until 1/4" of the engine mount tube is outside the body tube.

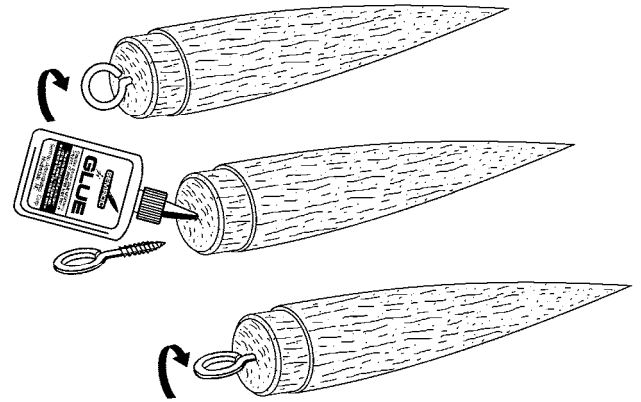
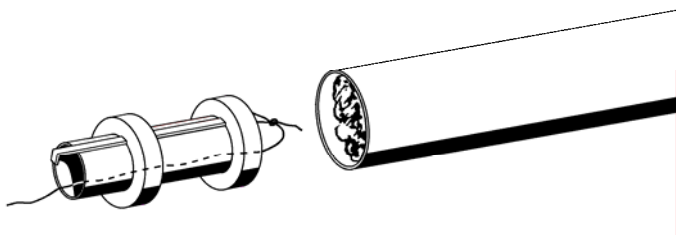

FINAL ASSEMBLY

- ❑ **18.** Assemble chute using instructions printed on canopy. Attach chute by passing the lines through the screw eye and looping them over the tip of the nose cone as shown. Pull the lines tight and make sure they are all of equal length. Put a drop of glue on the joint to keep the lines from moving.

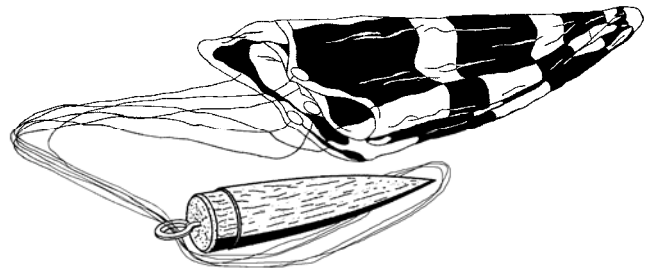

- ❑ **19.** Tie the loose end of the elastic cord to the screw eye. Put a drop of glue on the knot to keep it from untying.

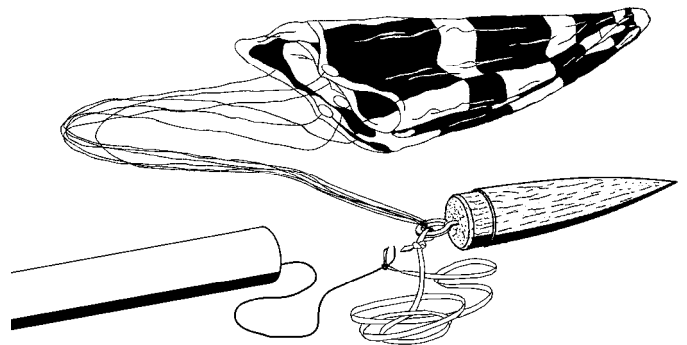

This completes the assembly of your

Astro-Jr™

- ❑ **14.** After the fin assembly is completely dry, run a small bead of glue along both sides of each fin-body tube joint. Using your index finger, smooth the glue into fillets.

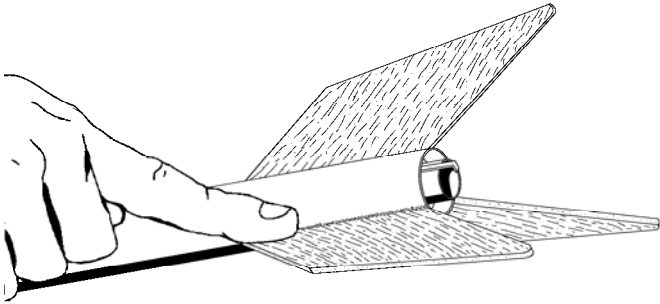

- ❑ **15.** Glue the launch lug along the side of the body tube, centered between two of the fins and 1 1/2" from the bottom of the body tube.

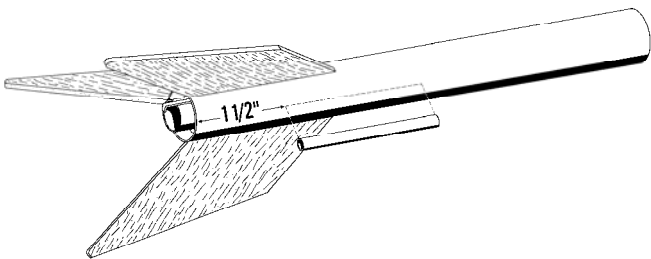

NOSE CONE

- ❑ **16.** Insert the nose cone in the body tube and check for proper fit. The nose cone should be snug to hold itself in alignment. If it is too loose, add masking tape. If it is too tight, sand the shoulder slightly.

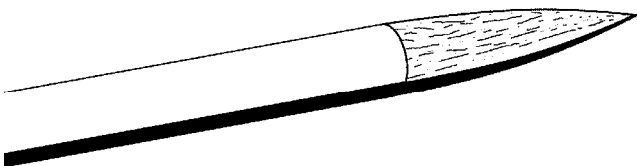

- ❑ **17.** Twist the screw eye into the center of the base of the nose cone. Unscrew it and squirt glue into the hole. Reinstall the screw eye and wipe off any excess glue.

- ❑ **11.** Prepare the shock cord as follows. Line up one end of the elastic shock cord with the free end of the Kevlar cord and tie an overhand knot at the end of the two cords. Pull the knot tight and place a small drop of white glue on the knot to prevent it from loosening.

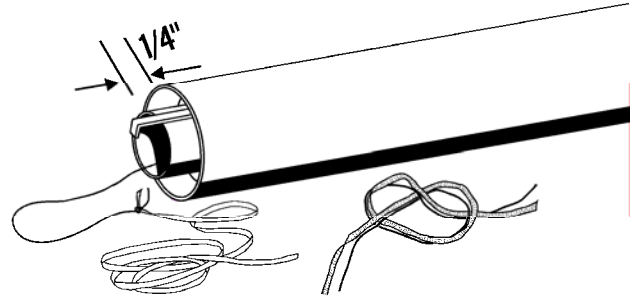

- ❑ **12.** Feed the shock cord and yellow Kevlar® cord back through the engine mount tube and body tube until they come out the opposite end. Make sure they are pulled all the way through the engine mount and do not hang on the engine hook. It may be necessary to shake the tube or pull the shock cord through with a coat hanger or small, thin wood dowel.

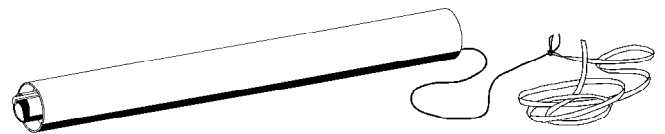

FINISH FINS

- ❑ **13.** Run a thin bead of glue along the root edge of one of the fins. Attach it to the body tube on one of the lines drawn earlier. Remove the fin and wait a few minutes until the glue gets tacky. Reapply the fin and check for proper alignment. Repeat for the other two fins. Refer to the end view.

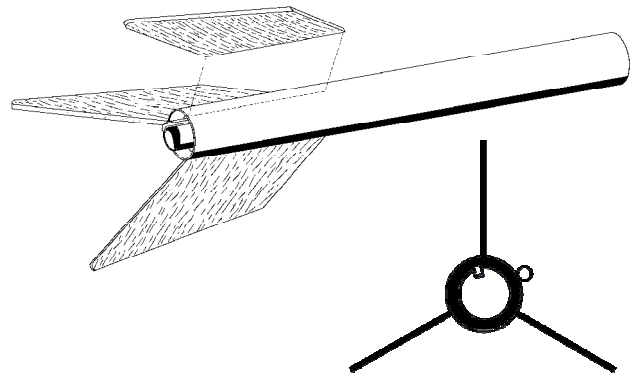

Parts List

EXPLODED VIEW

- A 1 Body Tube ST-890
- B 1 Body Tube ST-520E
- C 1 Balsa Nose Cone BC-837
- D 1 Laser Cut Fins FA-4
- E 2 Centering Rings CR-58
- F 1 Thrust Ring TR-5
- G 1 Launch Lug LL-122
- H 1 Engine Hook EH-18
- I 1 Screw Eye SE-10
- J 1 Elastic Cord EC-118
- K 1 Kevlar Thread SCK-24
- L 1 Plastic Parachute RC-12
- M 1 Tape Discs TD-6
- N 1 Shroud Line SLT-6
- O 1 Decal DKA-4

