



Model Rocket Safety Code

- 1. Materials.** I will use only lightweight, non-metal parts for the nose, body, and fins of my rocket.
- 2. Motors.** I will use only certified, commercially-made model rocket motors, and will not tamper with these motors or use them for any purposes except those recommended by the manufacturer.
- 3. Ignition System.** I will launch my rockets with an electrical launch system and electrical motor igniters. My launch system will have a safety interlock in series with the launch switch, and will use a launch switch that returns to the "off" position when released.
- 4. Misfires.** If my rocket does not launch when I press the button of my electrical launch system, I will remove the launcher's safety interlock or disconnect its battery, and will wait 60 seconds after the last launch attempt before allowing anyone to approach the rocket.
- 5. Launch Safety.** I will use a countdown before launch, and will ensure that everyone is paying attention and is a safe distance of at least 15 feet away when I launch rockets with D motors or smaller, and 30 feet when I launch larger rockets. If I am uncertain about the safety or stability of an untested rocket, I will check the stability before flight and will fly it only after warning spectators and clearing them away to a safe distance.
- 6. Launcher.** I will launch my rocket from a launch rod, tower, or rail that is pointed to within 30 degrees of the vertical to ensure that the rocket flies nearly straight up, and I will use a blast deflector to prevent the motor's exhaust from hitting the ground. To prevent accidental eye injury, I will place launchers so that the end of the launch rod is above eye level or will cap the end of the rod when it is not in use.
- 7. Size.** My model rocket will not weigh more than 1,500 grams (53 ounces) at liftoff and will not contain more than 125 grams (4.4 ounces) of propellant or 320 N-sec (71.9 pound-seconds) of total impulse. If my model rocket weighs more than one pound (453 grams) at liftoff or has more than four ounces (113 grams) of propellant, I will check and comply with Federal Aviation Administration regulations before flying.
- 8. Flight Safety.** I will not launch my rocket at targets, into clouds, or near airplanes, and will not put any flammable or explosive payload in my rocket.
- 9. Launch Site.** I will launch my rocket outdoors, in an open area at least as large as shown in the accompanying table, and in safe weather conditions with wind speeds no greater than 20 miles per hour. I will ensure that there is no dry grass close to the launch pad, and that the launch site does not present risk of grass fires.
- 10. Recovery System.** I will use a recovery system such as a streamer or parachute in my rocket so that it returns safely and undamaged and can be flown again, and I will use only flame-resistant or fireproof recovery system wadding in my rocket.
- 11. Recovery Safety.** I will not attempt to recover my rocket from power lines, tall trees, or other dangerous places.

LAUNCH SITE DIMENSIONS

Installed Total Impulse (N-sec)	Equivalent Motor Type	Minimum Site Dimensions (ft.)
0.00 — 1.25	1/4A	50
1.26 — 2.50	A	100
2.51 — 5.00	B	200
5.01 — 10.00	C	400
10.01 — 20.00	D	500
20.01 — 40.00	E	1000
40.01 — 80.00	F	1000
80.01 — 160.00	G	1000
160.01 — 320.00	2 Gs	1500

"Javelin"

SOUNDING ROCKET

IDEAL BEGINNER KIT

EASY-TO-BUILD

EDUCATIONAL

EXCITING

FLYING MODEL ROCKET KIT



Made in the U.S.A by Semroc Astronautics Corporation - Knightdale, N.C. 27545

JAVELIN Kit No. KV-16

Specifications	Engine	Approx. Altitude
Body Diameter .759" (1.9cm)	A8-5	500'
Length 12.7" (32.2cm)	B6-6	1000'
Fin Span 3.8" (9.7cm)	C6-7	1550'
Net Weight 0.6 oz. (15.6g)		

PARACHUTE RECOVERY

What is a @ ?

A @ is a retro reproduction of an out-of-production model rocket kit. It is a close approximation of a full scale model of an early historically significant model rocket kit from one of the many companies that pioneered the hobby over the past half century. A @ is not a true clone or identical copy of the original. It incorporates improvements using modern technology, while keeping the flavor and build appeal of the early kits.

About Centuri Engineering Company

Centuri Engineering Company was started in 1961 by Leroy (Lee) Piester in his garage while he was still in college in Phoenix, Arizona. With his wife, Betty, they built Centuri into one of the largest model rocket companies ever.

Centuri was known for its unusual and innovative designs, producing over 140 different kits with something for every model rocketeer. They also produced model rocket engines and pioneered the modern composite high powered engines with their Enerjet line.

Centuri Engineering was sold to Damon in the late 1960's and shared the same parent corporation with Estes Industries, the largest model rocket company in the world. The Centuri product line was kept separate from the Estes line until 1983. A few of the old kits have been reissued by Estes since then, but for the most part, Centuri Engineering Company lives today only in the dreams of the senior members of the model rocket community.

January 21, 2004

Copyright © 2004 Semroc Astronautics Corporation
Box 1271 Knightdale, NC 27545 (919) 266-1977

LIMITATION OF LIABILITY

Model rockets are not toys, but are functional rockets made of lightweight materials and are launched with NAR or Tripoli safety certified model rocket motors, electrically ignited and flown in accordance with the NAR Model Rocket Safety Code. If misused, model rockets can cause serious injury and property damage. Semroc certifies that it has exercised reasonable diligence in the design and manufacture of its products. Semroc cannot assume any liability for the storage, transportation, or usage of its products. Semroc shall not be held responsible for any personal injury or property damage whatsoever arising out of the handling, storage, use, or misuse of our products. The buyer assumes all risks and liabilities therefrom and accepts and uses Semroc products on these conditions.

Your purchase and use of any Semroc products is construed as your agreement to and acceptance of these terms. If you do not agree to these terms and conditions, you must return the product, unused, for refund or credit.

100% SATISFACTION GUARANTEE

If you are not 100% satisfied with your Semroc product, we will make it right by providing whatever you consider fair, from refund to replacement.

Contact us at:

Semroc Astronautics Corporation

Customer Service Department
P.O. Box 1271
Knightdale, North Carolina 27545

JOIN THE NAR!

Sign up online at www.nar.org to join the premier model rocketry organization. Semroc fully supports the National Association of Rocketry and recognizes it as the sport's official voice. The NAR is the oldest and largest sport rocketry organization in the world. Since 1957 over 80,000 serious sport rocket modelers have joined the NAR to take advantage of the fun and excitement of organized rocketry. It is always more fun if you fly with friends. The *Sport Rocketry* magazine is one of the best ways to keep informed of new developments in the hobby. Check online at www.semroc.com/nar for promotions just for NAR members.



- ❑ **19.** After the paint has dried, decals should be applied. The decals supplied with the Javelin are waterslide decals. Each decal should be cut separately from the sheet. Completely apply one of the decals before starting the next. Think about where you want to apply each decal and check for fit before wetting the decal. Make sure the ends are aligned with the roll pattern.

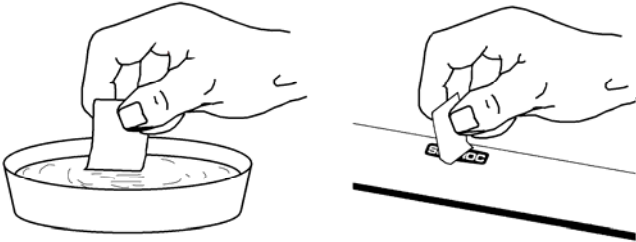

FLIGHT PREPPING

- ❑ **20.** Mounting the engine: The engine must have masking tape applied to keep it from kicking out of the body tube at ejection time. Don't use too much tape or the engine will be too difficult to remove from the rocket.
- ❑ **21.** Pack the recovery wadding from the top of the body tube. Use a sufficient quantity to protect the parachute, but not too much that there is no room left.
- ❑ **22.** Fold the parachute and pack it and the shock cord on top of the recovery wadding. Slide the nose cone into place, making sure it does not pinch the shock cord or parachute.

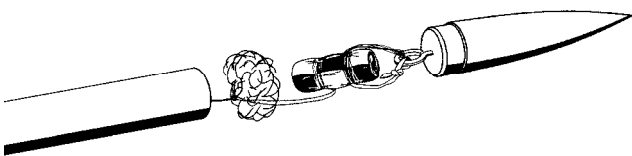

- ❑ **23.** Refer to the model rocket engine manufacturer's instructions to complete the engine prepping. Different engines have different igniters and methods of hooking them up to the launch controllers.
- ❑ **24.** Carefully check all parts of your rocket before each flight as a part of your pre-flight checklist. Launch the Javelin from a 1/8" diameter by 36" long launch rod.

About the Javelin™

The Javelin was introduced in the 1965 Centuri catalog. It became one of their signature beginner kits and was included in at least two of their multi-kit outfits. In the same class as the Sky Hook by Estes, the Javelin was a minimum diameter kit with parachute recovery. The catalog says that a Centuri Javelin was tracked to over 1,800 feet using a B.8-6 Centuri engine! It was also noted that the nose cone could be replaced with a payload capsule to add payload carrying capabilities. The Javelin was Centuri #KC-31 and was introduced with a price of \$1.50.

The @ Javelin is updated by replacing the balsa sheet and fin patterns with precision laser-cut fins. The original balsa nose cone and body tube sizes are used. The original rubber shock cord is replaced with an elastic cord for longer life. The original method of attaching the shock cord has been replaced by a Kevlar® cord for greater reliability.

BEFORE YOU START!

Make sure you have all the parts included in this kit that are listed in the Parts List in the center of these instructions. In addition to the parts included in this kit, you will also need the tools and materials listed below. Read the entire instructions before beginning to assemble your rocket. When you are thoroughly familiar with these instructions, begin construction. Read each step and study the accompanying drawings. Check off each step as it is completed. In each step, test-fit the parts together before applying any glue. It is sometimes necessary to sand lightly or build-up some parts to obtain a precision fit. If you are uncertain of the location of some parts, refer to the exploded view in the center of these instructions. It is important that you always ensure that you have adequate glue joints.

TOOLS: In addition to the parts supplied, you will need the following tools to assemble and finish this kit.

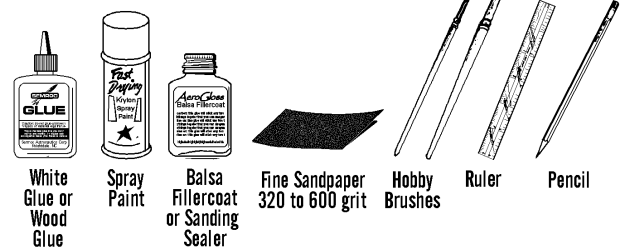

ASSEMBLY

1. These instructions are presented in a logical order to help you put your Javelin together quickly and efficiently. Check off each step as you complete it and enjoy putting this kit together.

2. Fit the nose cone first. Insert the nose cone in the body tube and check for fit. The nose cone should be snug to hold itself in alignment. If it is too loose, add masking tape. If it is too tight, sand the shoulder slightly. Remove the nose cone and set it aside for later.

3. Prepare the shock cord as follows. Line up one end of the elastic shock cord with one end of the Kevlar® cord and tie an overhand knot at the end of the two cords. Pull the knot tight and place a small drop of white glue on the knot to prevent it from loosening.

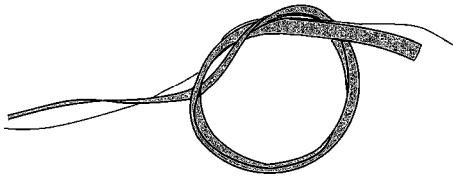

4. Tie the other end of the yellow Kevlar® cord to the thrust ring. Place the elastic cord through the body tube. The thrust ring is to be glued 2 1/2" from the end of the body tube. Mark the empty engine casing 1/4" from one end. Set the casing aside.

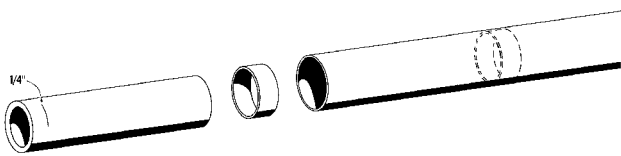

5. Put a large dab of glue on your little finger or a cotton-tipped swab and spread the glue around inside the tube as far as your finger (or swab) will reach, but no farther than 2 1/2". Try not to get any glue close to the end of the tube. Insert the thrust ring just inside the end of the body tube making sure the Kevlar® cord and elastic shock cord are pulled out of the top of the body tube. Use the marked engine casing to push the thrust ring until the mark on the casing is even with the end of the body tube. CAUTION: Once you have started to push, do not stop or the ring will "freeze" in place. Remove the empty case immediately and discard.

15. Assemble the parachute using the instructions supplied on the chute.

FINISHING

16. When the fillets have dried, prepare balsa surfaces for a smooth professional looking finish. Fill the wood grain with balsa fillercoat or sanding sealer. When dry, sand with fine sandpaper. Repeat until smooth.

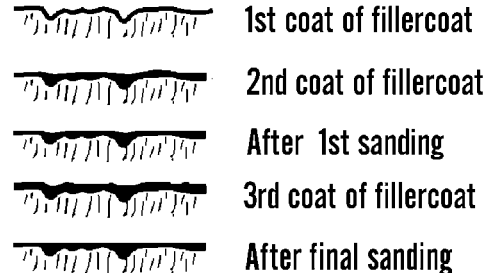

17. After all balsa surfaces have been prepared, wipe off all balsa dust with a dry cloth. First spray the model with an enamel primer. Choose a high visibility color like yellow or orange for the final color.

18. Spray painting your model with a fast-drying enamel will produce the best results. PATIENCE...is the most important ingredient. Using rolled newspapers to hold the rocket, apply several thin coats, allowing each coat to completely dry before the next coat. Start each spray a few inches above the model and end a few inches below the model. Keep the can about 12" away and use quick light coats. The final coat can be a little heavier to give the model a glossy wet-looking finish.

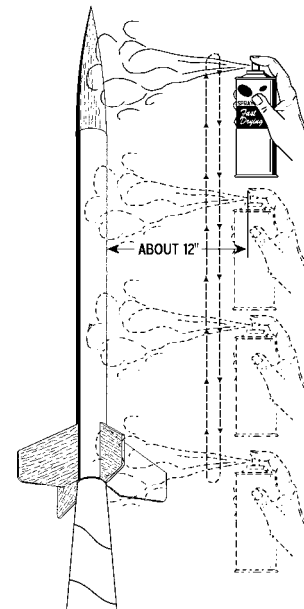



- ❑ **10.** Apply glue to the root edge of a fin and position it along one of the lines drawn on the side of the body tube. Remove, allow to dry, apply additional glue, and reposition. Repeat for the other three fins.

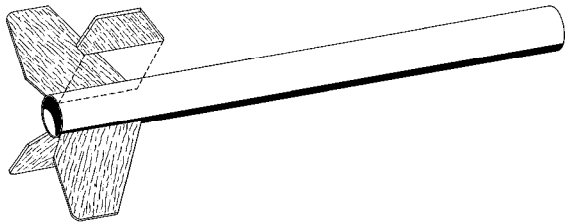

- ❑ **11.** Allow to dry standing vertically, checking for alignment visually while the assembly dries. Stuff the shock cord and Kevlar® cord into the body tube so it will remain vertical.

- ❑ **12.** After the fin assembly is completely dry, run a small bead of glue along both sides of each fin-body tube joint. Using your forefinger, smooth the glue into fillets.

- ❑ **13.** Glue the launch lug onto the body, centered between two fins and about 1" from the bottom. Stand the assembly vertically again and wait for the fin fillets to completely dry. Watch for runs in the glue and wipe any before they run down the tube.

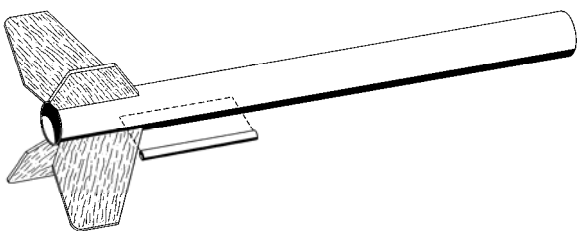

- ❑ **14.** Twist the screw eye into the center of the base of the nose cone. Unscrew it and squirt glue into the hole. Reinstall the screw eye and wipe off any excess glue. Tie the free end of the elastic shock cord to the screw eye.

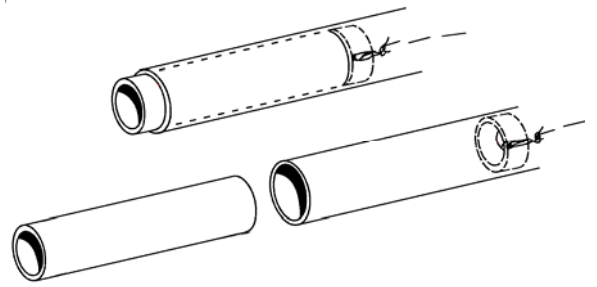
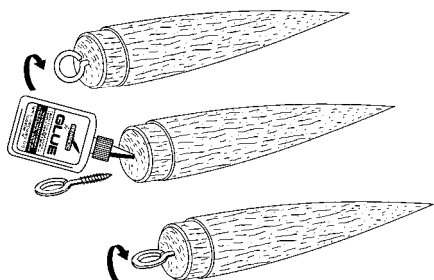

- ❑ **6.** Lightly sand each side of the laser-cut fins. Carefully push the laser-cut fins from their sheet. Start at one point on each fin and slowly and gently work around the fin.

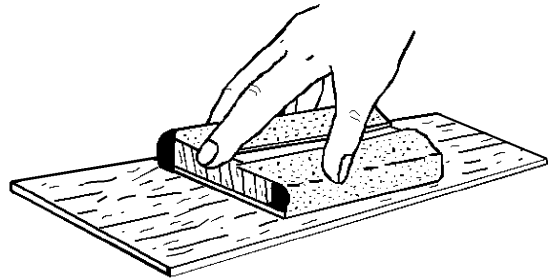

- ❑ **7.** Stack all four fins and line them up squarely. Run the fins back and forth over some fine sandpaper to get rid of the hold-in tabs as shown below.

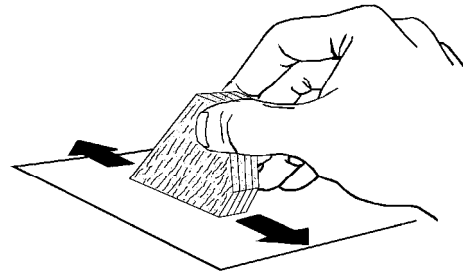

- ❑ **8.** Round all edges except the root edge. The root edge should remain flat since it will be glued to the body tube. The trailing edge may be sanded in a streamlined taper if you want a higher performance rocket.

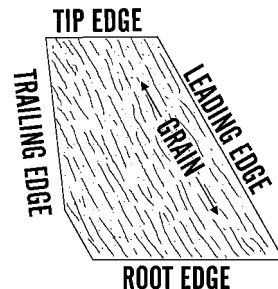

- ❑ **9.** Stand the body tube on the fin guide on the next page after the exploded view and make the fin position marks on the sides of the tube. Find a convenient channel or groove such as a partially open drawer, a door jamb (as shown,) or a piece of molding. Using the channel, extend the marks the full length of the tube to provide lines for aligning the fins.

Parts List

EXPLODED VIEW

- A 1 Body Tube ST-790
- B 1 Balsa Nose Cone BC-735
- C 1 Laser Cut Fins FV-16
- D 1 Thrust Ring TR-7
- E 1 Launch Lug LL-122
- F 1 Screw Eye SE-10
- G 1 Elastic Cord EC-118
- H 1 Kevlar Thread SCK-24
- I 1 Plastic Parachute RC-12
- J 1 Tape Discs TD-6
- K 1 Shroud Line SLT-6
- L 1 Empty Casing MC-727
- M 1 Decal DKV-16

