

About Semroc Astronautics Corporation

Semroc Astronautics Corporation was started by Carl McLawhorn in his college dorm at North Carolina State University in November, 1967. Convincing a small group of investors in his home town of Ayden, North Carolina to invest in a small corporation, the company was re-incorporated as Semroc Astronautics Corporation on December 31, 1969.

Semroc produced a full line of model rocket kits and engines. At its peak, Semroc had twenty-five full time employees working at two facilities. One was for research and development, printing, shipping, and administration. The other was outside town and handled all production and model rocket engine manufacturing. For several years, Semroc was successful selling model rocket kits, supplies, and engines by mail-order and in hobby shops. In early 1971, Semroc became insolvent and had to close its doors.

After 31 years of dreams and preparations, Semroc Astronautics Corporation was reincorporated on April 2, 2002 with a strong commitment to helping put the fun back into model rocketry.

About the Aphelion™

The Aphelion™ is the fourth model in the new Ready-to-Build Series. It was released by Semroc in 1968 as our fourth production kit. It was included in our Beginner's Special with a launch controller, launch pad and three engines. Although this model includes a slotted tube and through-the-wall fins, it is very close to the same external appearance as the original.

What is Ready-to-Build™?

Most of the model rockets over the years have been ready-to-build, as opposed to the simpler ready-to-fly or almost-ready-to-fly models, but Semroc has designed this line for the joy of building. Starting with laser-cut balsa fins and adding a through-the-wall tab to match the laser-cut precision tube slots makes fin construction a breeze. A laser-cut fiber fin template makes it simple to align the fins almost perfectly. The addition of an inner tube to insulate the outer tube from hot delay flames and ejection gases also keeps the extra long 36" elastic shock cord protected. The RTB series draws from many of the best ideas from the past fifty plus years of model rocketry.

What is a Retro-Repro?

A Retro-Repro™ is a retro reproduction of an out-of-production model rocket kit. It is a close approximation of a full scale model of an early historically significant model rocket kit from one of the many companies that pioneered the hobby over the past half century. A Retro-Repro™ is not a true clone or identical copy of the original. It incorporates improvements using modern technology, while keeping the flavor and build appeal of the early kits.

July 23, 2010

Copyright © 2010 Semroc Astronautics Corporation
Box 1271 Knightdale, NC 27545 (919) 266-1977

aphelion™

EASY TO BUILD

SINGLE STAGE

BALSA FINS & NOSE CONE

SLOTTED BODY TUBE

FLYING MODEL ROCKET KIT

1968
Retro-Repro

MADE IN THE USA

SEMROC

Made in the U.S.A by Semroc Astronautics Corporation - Knightdale, N.C. 27545

APHELION™ Kit No. KV-26

Specifications	Engine	Approx. Altitude
Body Diameter 1.04" (2.6 cm)	A8-5	200'
Length 14.8" (37.5 cm)	B6-6	550'
Fin Span 4.5" (11.5 cm)	C6-7	1200'
Net Weight 1.3 oz. (36.9 g)		

PARACHUTE RECOVERY

EXPLODED VIEW

Parts List

- A 1 Balsa Nose Cone...BC-1039
- B 1 Body Tube.....ST-10100S3
- C 1 Body Tube.....ST-730E
- D 1 Body Tube.....ST-950SC
- E 1 Engine HookEH-28
- F 1 Centering Ring.....CR-710
- G 1 Centering Ring.....CR-79
- H 1 Laser Cut FinsFV-26
- I 1 Screw EyeSE-10
- J 1 Elastic Cord.....EC-136
- K 1 Chute Pak.....CP-12RY
- L 1 Launch LugLL-122
- M 1 DecalDKV-26
- N 1 Fin Template.....IFT-10

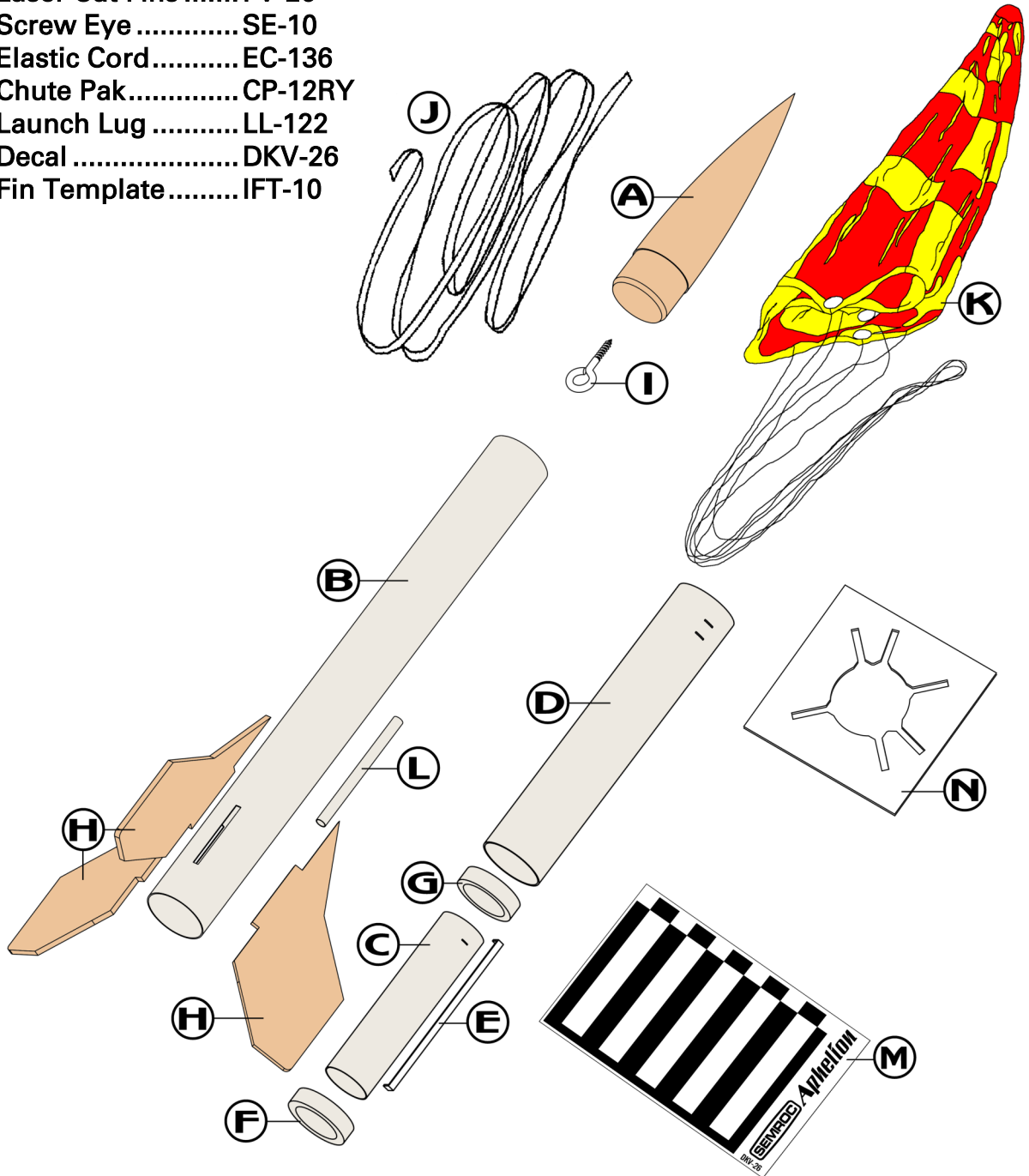

BEFORE YOU START!

Make sure you have all the parts included in this kit that are listed in the Parts List to the left. In addition to the parts included in this kit, you will also need the tools and materials listed below. Read the entire instructions before beginning to assemble your rocket. When you are thoroughly familiar with these instructions, begin construction. Read each step and study the accompanying drawings. Check off each step as it is completed. In each step, test-fit the parts together before applying any glue. It is sometimes necessary to sand lightly or build-up some parts to obtain a precision fit. If you are uncertain of the location of some parts, refer to the exploded view to the left. It is important that you always ensure that you have adequate glue joints.

TOOLS

In addition to the parts supplied, you will need the following tools to assemble and finish this kit.



ASSEMBLY

1. These instructions are presented in a logical order to help you put your Aphelion™ together quickly and efficiently. Check off each step as you complete it and we hope you enjoy putting this kit together.

FIN PREPARATION

2. Lightly sand each side of the laser-cut balsa fin sheet (FV-26). Carefully push the laser-cut fins from the sheet. Start at one point on each fin and slowly and gently work around the fin.

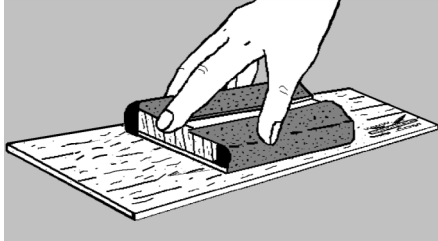

3. Stack all the fins in a group. Line the group up squarely and sand the fins back and forth over some fine sandpaper to get rid of the hold-in tabs as shown below. Do not sand enough to change the shape of the fins.

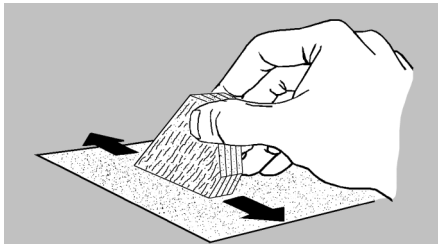

4. Round all the edges except the root edges of each fin. Do not sand the root edge or the tab will not contact the engine tube in a later step.

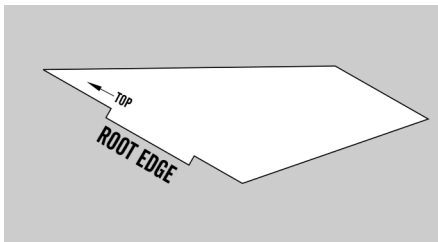

ENGINE MOUNT

5. Bend the engine hook (EH-28) slightly so it forms a slight bow in the direction shown.

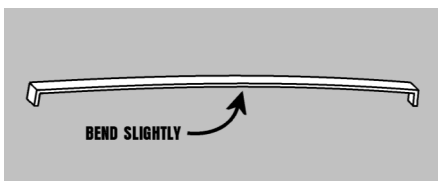

6. Insert one end of the engine hook into the pre-punched engine tube (ST-730E).

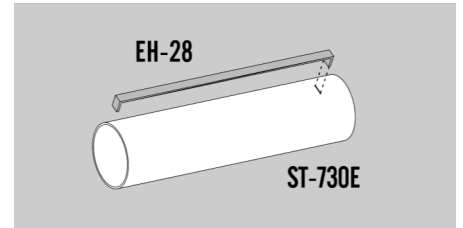

7. Locate the two centering rings. One of the rings (CR-79) has a white outer layer and is slightly smaller in diameter than the other ring (CR-710) which is brown. Using the white ring, slide it over the top (slotted) end of the engine tube until it overlaps the end of the engine hook slightly. **This is important since the wrong combination of rings will not work.**

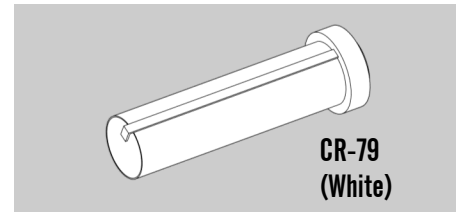

8. Mark the engine tube exactly 3/4" from the bottom end as shown.

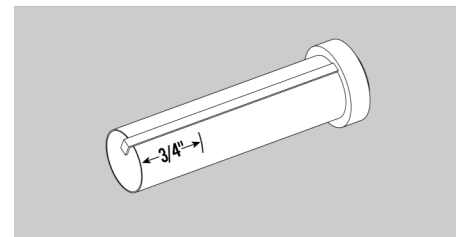

9. Slide the remaining centering ring (CR-710) over the engine tube until the mark is even with the bottom of the ring. Apply a bead of glue around both rings where they contact the engine tube. Keep glue off the outside edge of both rings. Allow the assembly to dry.

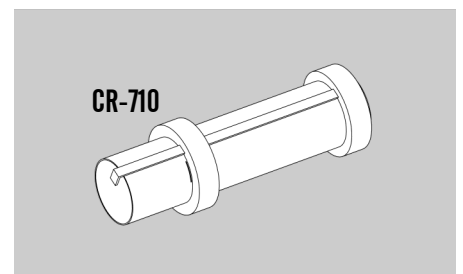

- ❑ 10. The insulating tube (ST-950SC) has two small slits near the top end for the elastic cord. Push the area between the two slits inward slightly.

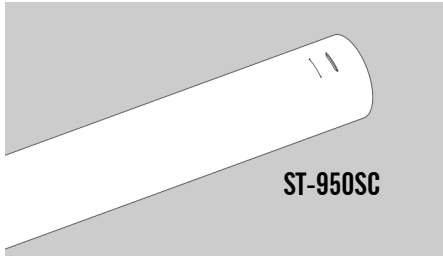

- ❑ 11. Use a pencil or knife to thread the elastic cord (EC-136) through the slots as shown. Use a knife to widen the slits if it is too difficult to thread the elastic cord. Leave the short end through the top slit.

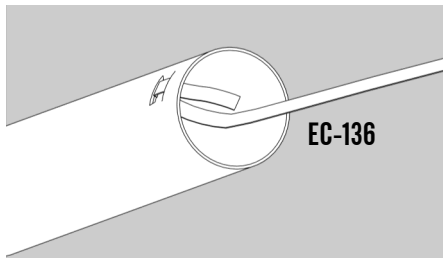

- ❑ 12. Tie an overhand knot in the short end of the elastic cord.

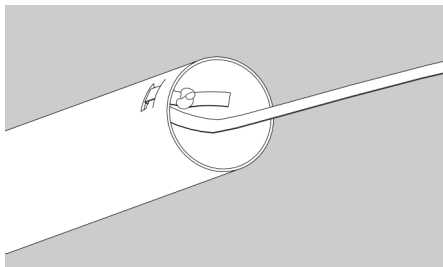

- ❑ 13. Apply a bead of glue inside the bottom of the insulating tube (away from the elastic cord.) Insert the engine mount into the insulating tube until it is recessed about 1/16". Roll the assembly on a flat surface to make sure it is aligned properly.

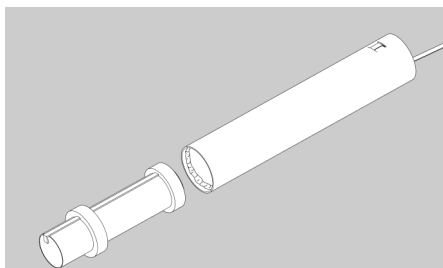

- ❑ 14. Mark the engine mount 3/8" from the bottom of the engine tube.

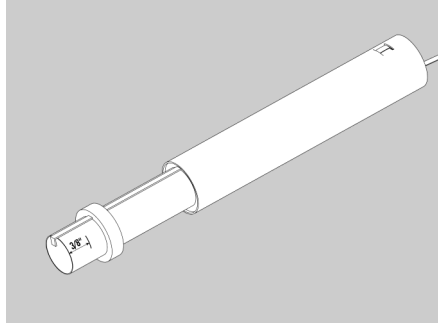

- ❑ 15. Pull the long end of the elastic cord taut until the knot is seated against the top slit. Apply a bead of glue on the knot and on the part of the elastic cord that is exposed on the outside of the insulating tube. Wipe any excess glue from the outside of the insulating tube. Store the excess length of the elastic cord inside the insulating tube.

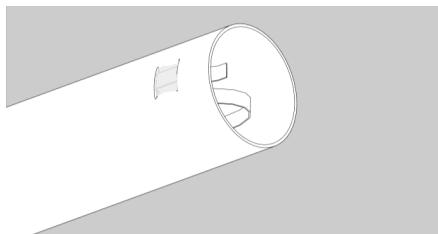

- ❑ 16. Insert the insulating tube and engine mount assembly into the main body tube (ST-10100S3) until the lower centering ring is just outside the main body tube. Align the engine hook between two of the slots. Apply a heavy bead of glue around the top side of the lower centering ring.

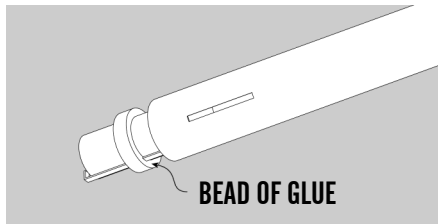

- ❑ 17. Push the engine mount into the main body tube until the mark on the engine tube is even with the main body tube. Hold the assembly vertical with the engine mount downward. Make sure all the slots are free of glue while the assembly sets.

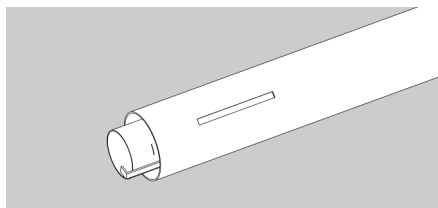

ATTACH FINS

- ❑ 18. Apply glue to the root edge and the through-the-wall tab of one of the fins and insert it into one of the slots on the main body tube. Remove the fin, set it aside and allow it to almost dry, apply additional glue, and reposition. Repeat for the other fins. If you follow these instructions, the fins will not require much additional work to keep them aligned.

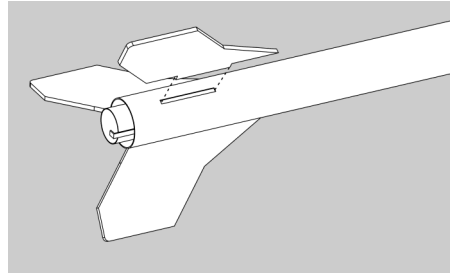

- ❑ 19. As the fins are drying, use the laser-cut fin template to align the fins perpendicular to the main body tube. The template will work with three or four fins. Turn it until the three fins line up with the corresponding slots. Do not let any glue set with the template in place.

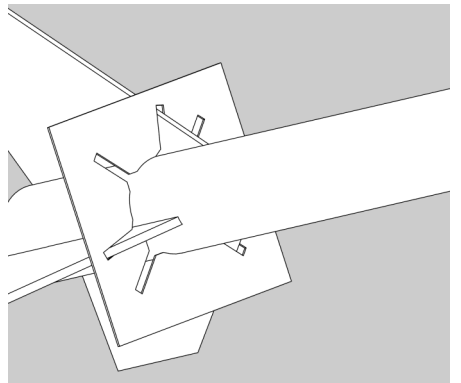

LAUNCH LUG

- ❑ 20. Apply a bead of glue to the launch lug (LL-122) and center it between two of the fins and over the engine hook. Sight it from the end and make sure it is parallel with the fins and body tube.

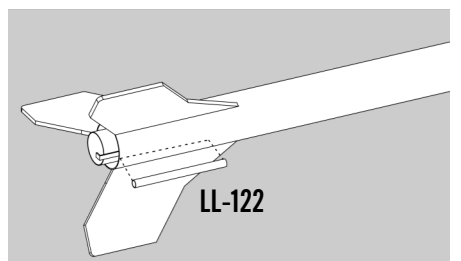

APPLY FILLETS

❑ 21. After the fin assembly is completely dry, run a small bead of glue along both sides of each fin-body tube joint. Using your forefinger, smooth the glue into fillets. Apply a fillet of glue on each side of the launch lug. Allow this assembly to dry in a vertical position.

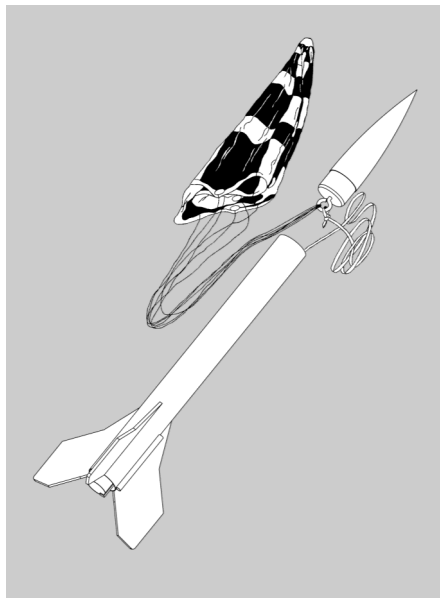
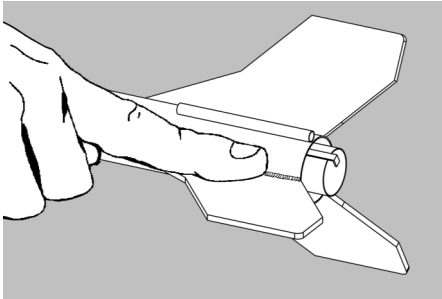

NOSE CONE

❑ 22. Insert the nose cone (BC-1039) in the main tube and check for proper fit. The nose cone should be snug to hold itself in alignment. If it is too loose, add masking tape. If it is too tight, sand the shoulder slightly. Turn the screw eye (SE-10) into the center of the nose cone. Unscrew it and squirt glue into the hole. Reinstall the screw eye and wipe off any excess glue.

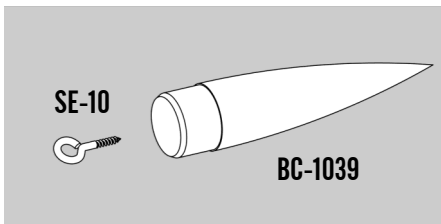

FINAL ASSEMBLY

❑ 23. Assemble the chute using the instructions printed on the canopy. Pull the lines tight on the chute and make sure they are all of equal length. Attach the chute by tying them to the screw eye. Put a drop of glue on the joint to keep the lines from moving. Using a pencil or dowel, push the elastic cord out through the top of the main body tube. Attach the free end of the elastic cord to the screw eye. Put a drop of glue on that joint as well.

FINISHING

❑ 24. When the fillets have dried, prepare balsa surfaces for a smooth professional looking finish. Fill the wood grain with balsa fillercoat or sanding sealer. When dry, sand with fine sandpaper. Repeat until smooth.

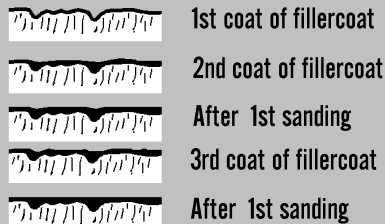

❑ 25. After all balsa surfaces have been prepared, wipe off all balsa dust with a dry cloth. First spray the model with an enamel primer. Choose a high visibility color like white for the final color.

❑ 26. Spray painting your model with a fast-drying enamel will produce the best results. PATIENCE...is the most important ingredient. Use several thin coats, allowing each coat to completely dry before the next coat. Start each spray a few inches above the model and end a few inches below the model. Keep the can about 12" away and use quick light coats. The final coat can be a little heavier to give the model a glossy wet-looking finish.

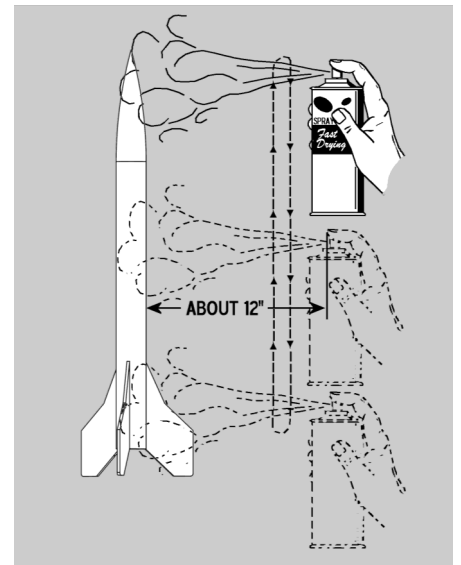

❑ 27. After the paint has dried, decals should be applied. The decals supplied with the Aphelion™ are waterslide decals. Each decal should be cut separately from the sheet. Think about where you want to apply each decal and check for fit before wetting the decal. Use the cover photo for suggested placement. Dip each decal in a small dish of water that has a drop of detergent. It will take about 30 seconds before the decal is loose enough to apply.

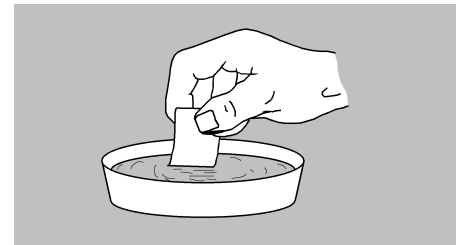

❑ 28. Slide the decal in place and use the paper backing to work the bubbles out. Repeat for all the decals.

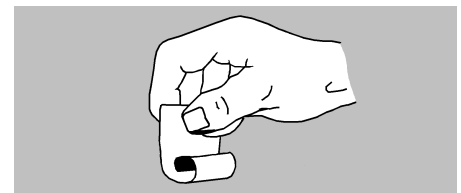

This completes the
assembly of your

Aphelion

FLIGHT PREPPING

29. Mounting the engine: Insert the engine and make sure the engine hook keeps the engine in snugly. The hook may be slightly bent to make sure the engine is retained.

30. Apply a few sheets of recovery wadding in the top of the main body tube. Fold the parachute and pack it and the shock cord on top of the recovery wadding. Slide the nose cone into place, making sure it does not pinch the shock cord or parachute.

31. Refer to the model rocket engine manufacturer's instructions to complete the engine prepping. Different engines have different igniters and methods of hooking them up to the launch controllers.

32. Carefully check all parts of your rocket before each flight as a part of your pre-flight checklist. Launch the Aphelion™ from a 1/8" diameter by 36" long launch rod.

33. After each flight, promptly remove the spent engine casing and dispose of properly.