

## About Centuri Engineering Company

Centuri Engineering Company was started in 1961 by Leroy (Lee) Piester in his garage while he was still in college in Phoenix, Arizona. With his wife, Betty, they built Centuri into one of the largest model rocket companies ever.

Centuri was known for its unusual and innovative designs, producing over 140 different kits with something for every model rocketeer. They also produced model rocket engines and pioneered the modern composite high powered engines with their Enerjet line.

Centuri Engineering was sold to Damon in the late 1960's and shared the same parent corporation with Estes Industries, the largest model rocket company in the world. The Centuri product line was kept separate from the Estes line until 1983. A few of the old kits have been reissued by Estes since then, but for the most part, Centuri Engineering Company lives today only in the dreams of the senior members of the model rocket community.

## About the USS America™

The original U.S.S. America was released in the 1975-1976 Centuri Catalog (No. 761) as one of three new Super Kits, along with the E.S.S Raven and U.F.O Invader. The S.S.V Scorpion would be released in 1977. The U.S.S. America was super sized and impressive with the large sheet of decals. The Super-C engine was released shortly after the Super Kits for even better performance. The original release was as Cat. No. 5310 and retailed for \$8.00.

The Semroc Retro-Repro™ U.S.S. America™ is close to the original design. The original plastic nose cones are replaced with balsa. Die-cut fiber parts are now laser-cut for more precision. Since the C5-3S is no longer available, the engine mount is changed to allow the use of 24mm engines. The U.S.S. America features a large waterslide decal close to the original.

## What is a Retro-Repro?

A Retro-Repro™ is a retro reproduction of an out-of-production model rocket kit. It is a close approximation of a full scale model of an early historically significant model rocket kit from one of the many companies that pioneered the hobby over the past half century. A Retro-Repro™ is not a true clone or identical copy of the original. It incorporates improvements using modern technology, while keeping the flavor and build appeal of the early kits.

July 25, 2012

Copyright © 2012 Semroc Astronautics Corporation  
Box 1271 Knightdale, NC 27545 (919) 266-1977

# U.S.S. America™

PRESIDENTIAL  
COMMAND POST

SUPER KIT SERIES

EASY TO BUILD

BALSA FINS &  
NOSE CONES

FLYING MODEL  
ROCKET KIT

1975  
Retro-Repro



SEMROC

Made in the U.S.A by Semroc Astronautics Corporation - Knightdale, N.C. 27545

## U.S.S. America™ Kit No. KV-77

Specifications	Engine	Approx. Altitude
Body Diameter 1.64" (4.2 cm)	C11-5	350'
Length 25.0" (63.5 cm)	D12-5	850'
Fin Span 11.8" (30.0 cm)	E12-6	1500'
Net Weight 4.2 oz. (119.2 g)		

**PARACHUTE RECOVERY**

# Parts List

# EXPLODED VIEW

- A 1 Balsa Nose Cone... BC-1655
- B 2 Balsa Nose Cones. BC-1041P
- C 1 Body Tube..... ST-16120
- D 1 Body Tube..... ST-1675
- E 2 Body Tubes..... ST-1094
- F 1 Body Tubes..... ST-940E
- G 6 Body Tubes..... ST-525
- H 2 Plastic Cone Sets .. PC-5RJ
- I 1 Hollow Coupler..... HTC-16
- J 1 Laser Cut Fins ..... FV-77
- K 1 Ring Set ..... CR-KV-77
- L 1 Launch Lug ..... LL-330
- M 1 Screw Eye ..... SE-10
- N 1 Thrust Ring ..... TR-9
- O 1 Elastic Cord..... EC-236
- P 1 Engine Hook ..... EH-38
- Q 2 Wood Dowels ..... WD-112
- R 1 Chute Pak..... CP-20Y
- S 1 Shroud Set..... IKV-77S
- T 1 Decal (Not Shown)... DKV-77  
(Decal is rolled in long body tube)

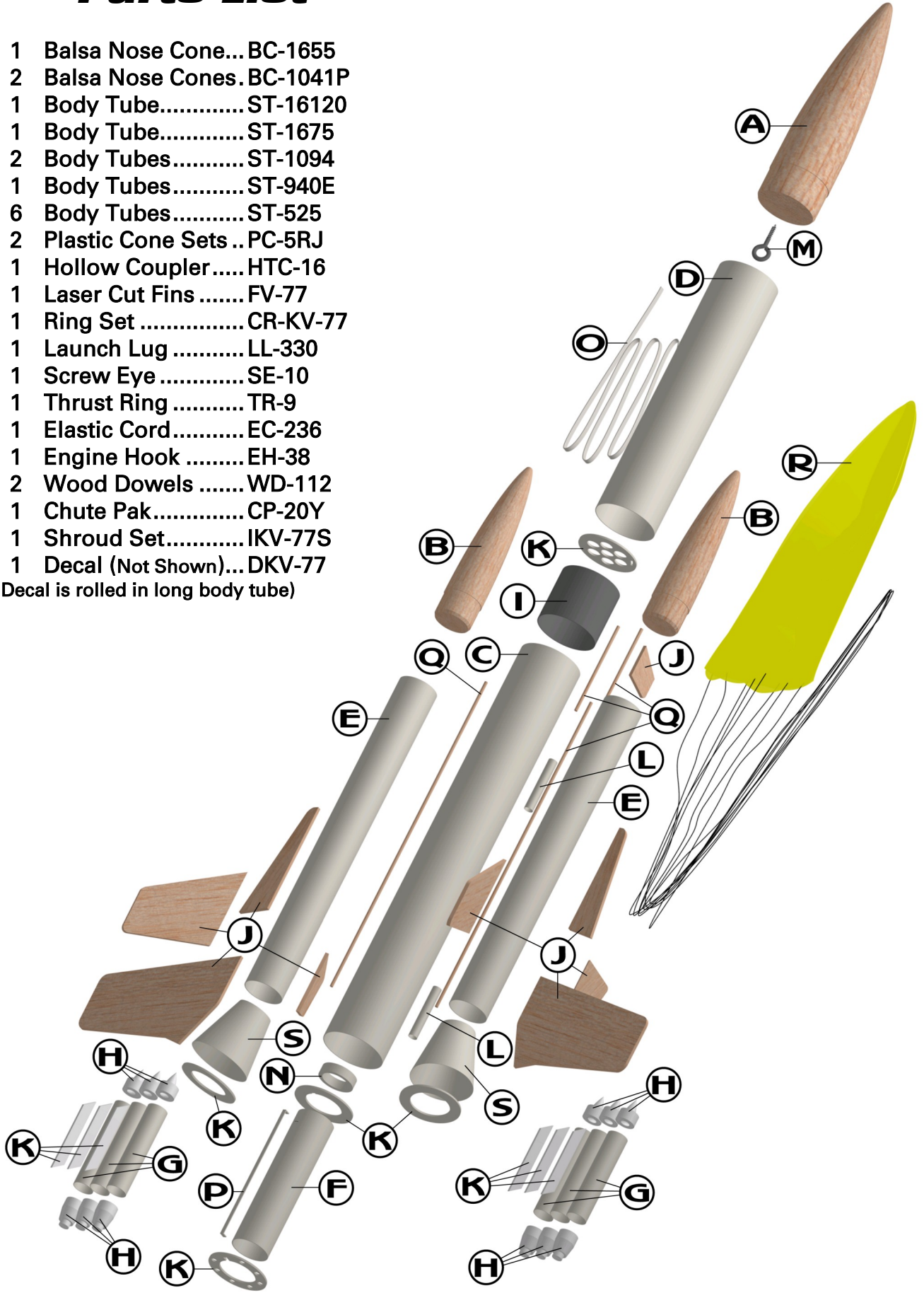

## BEFORE YOU START!

Make sure you have all the parts included in this kit that are listed in the Parts List in these instructions. In addition to the parts included in this kit, you will also need the tools and materials listed below. Read the entire instructions before beginning to assemble your rocket. When you are thoroughly familiar with these instructions, begin construction. Read each step and study the accompanying drawings. Check off each step as it is completed. In each step, test-fit the parts together before applying any glue. It is sometimes necessary to sand lightly or build-up some parts to obtain a precision fit. If you are uncertain of the location of some parts, refer to the exploded view to the left. It is important that you always ensure that you have adequate glue joints.

## TOOLS

In addition to the parts supplied, you will need the following tools to assemble and finish this kit. Wax paper is also needed.



## ASSEMBLY

1. These instructions are presented in a logical order to help you put your U.S.S. America™ together quickly and efficiently. Check off each step as you complete it and we hope you enjoy putting this kit together.

## FIN PREPARATION

2. Lightly sand each side of the two laser-cut fin sheets (FV-77). Carefully push the laser-cut fins from their sheet. Start at one point on each fin and slowly and gently work around the fin.

3. Stack all the like fins in sets. Line each set of fins up squarely and sand the fins back and forth over some fine sandpaper to get rid of the hold-in tabs as shown below.

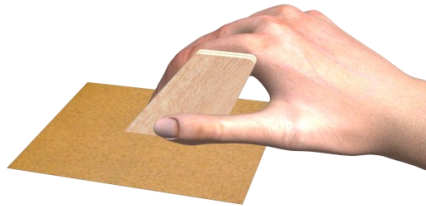

4. Round all the edges of each fin, except leave the root edges flat. The root edges will be glued to the body tube. There is one extra forward vane that will not be used.

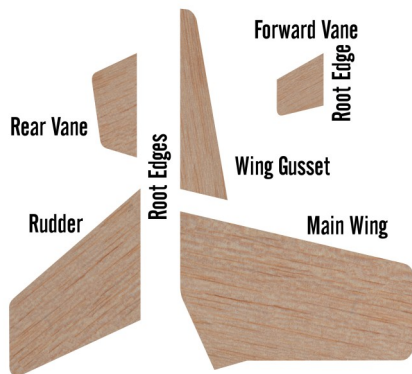

5. Glue each main wing and wing gusset as shown below. Use a straightedge or ruler to align the two parts along the root edges. Wax paper will prevent parts from sticking to your workspace.



## ENGINE MOUNT

6. Bend the engine hook (EH-38) slightly so it forms a slight bow in the direction shown.



7. Insert one end of the engine hook into the pre-punched engine tube (ST-940E).

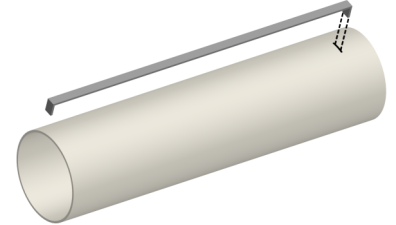

8. Carefully punch out all the fiber parts from the laser-cut fiber sheet (CR-KV-77). Slide the centering ring with the small notch over the engine tube and engine hook until the hook is just captured. Wrap one layer of masking tape around the center of the tube, holding the engine hook in place. Run a bead of glue along the engine hook from the tape to the top ring.

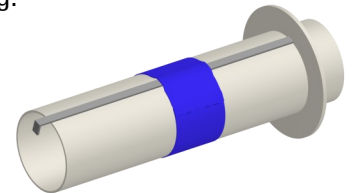

9. Slide the centering ring with the small holes and large notch over the bottom of the engine tube with the engine hook inside the notch. Run a bead of glue around both centering rings along the ring and tube joint, keeping glue away from the bottom engine hook notch.

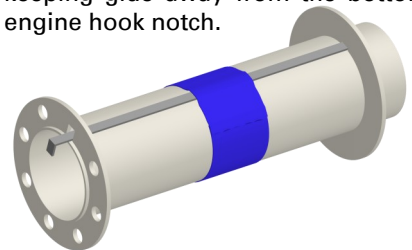

10. Glue the thrust ring (TR-9) in place on top of the engine hook as shown. Allow all the joints to dry.

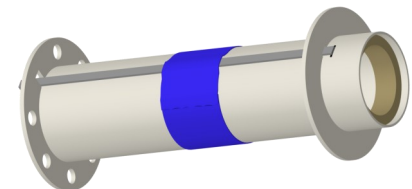

## SHROUDS

❑ 11. Carefully cut out the two paper shrouds (IKV-77S). Roll one of the shrouds carefully forming it into a cone (glossy side out), being careful to avoid creasing the paper. Apply a thin layer of white glue on the indicated section inside the dotted line. Line up the opposite edge with the dotted line and press together on a flat surface. Hold it in place until the glue sets. Repeat with the second shroud. Allow both to dry.

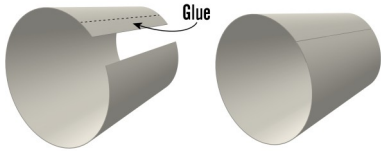

❑ 12. Apply a bead of glue around the inside rim of one of the complete shrouds. Fit one of the two centering rings (large hole) into the bottom of the shroud. Place the shroud with the ring down on some wax paper and make sure the ring is flat and the shroud touches the wax paper as shown in the cutaway view. Repeat with the other shroud and ring. Allow both assemblies to dry.

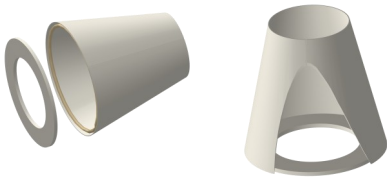

❑ 13. Apply a bead of glue around the inside rim of one of the tank tubes (ST-1094). Insert one of the shroud assemblies in the tank tube. Position both pieces so they are flat on a surface that is covered with wax paper. Align the shroud so the seam is flat against the surface. This is important so the seam will be hidden in later steps. Place a small mark on the ring at the seam so you can identify it later. Repeat with the other tank tube and shroud assembly.

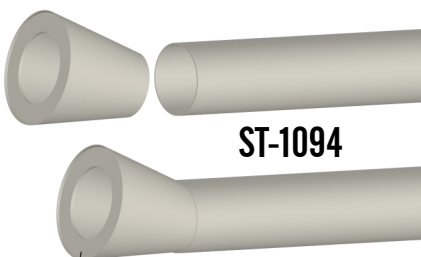

## EJECTION BAFFLE

❑ 14. Punch out all the holes from the baffle ring (CR-KV-77). Insert one end of the elastic shock cord (EC-236) into the small slot near the edge of the ring. Tie a knot in the end and pull it until the knot is against the ring. Apply a generous bead of glue on the knot. Align the ring on one end of the coupler tube (HTC-16) and glue it in place so the outer edge of the baffle is even with the coupler tube.

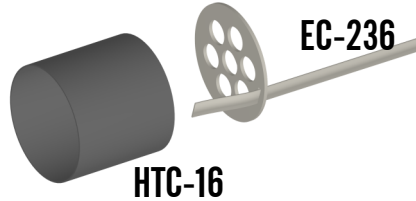

❑ 15. Apply a generous bead of glue inside the coupler tube against the joint between the baffle ring and the coupler tube. Glue the end of the elastic cord to the coupler tube.

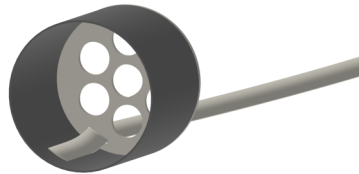

❑ 16. Test fit the ejection baffle in the top of the main tube. Sand the edges so it will slide freely in the tube. Apply a bead of glue inside the bottom of the upper body tube (ST-1675). Place a mark 3/4" from one end of the coupler. Orient the baffle assembly so the baffle and elastic cord are at the top end. Slide the ejection baffle in the tube until the mark is even with upper body tube. Allow the glue to set, but not dry. Apply a bead of glue inside the top of the lower body tube (ST-16120) and slide it over the bottom of the coupler until the two tubes are flush. Rotate the main tube assembly as the glue is drying so it does not pool in one place. Allow to dry completely.

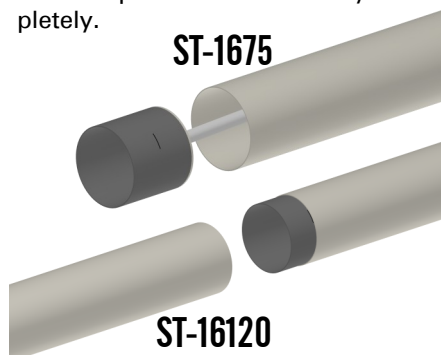

## ATTACH TANKS

❑ 17. Slide the marking template from the fiber sheet over the main tube assembly and the two tank tubes as shown. Make sure the seams on the shrouds are against the main tube, using the marks placed on the shroud rings as a guide. Allow the marking template and the shrouds to overhang the edge of a table. Align the ends of the shrouds with the end of the body tube. When everything is aligned correctly, run a bead of glue along the joints between the each tank tube and the main tube assembly. Keep glue off the template! Make sure the tops of the tank tubes stay in contact with the main body assembly. Allow to dry.

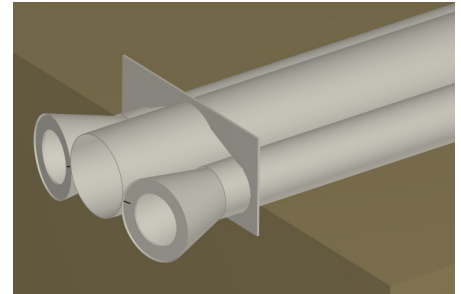

❑ 18. Position the template about 1/2" from the shrouds. Place a mark at each triangular cutout. There are three on each tank tube and one at the top of the main tube.

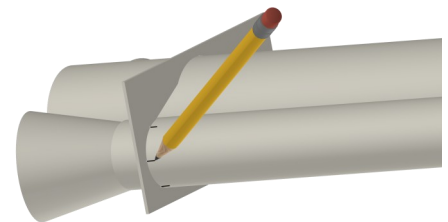

❑ 19. Position the template about 3" from the shrouds. Place another mark at each triangular cutout.

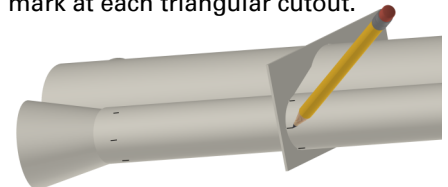

❑ 20. Using a straightedge or ruler aligned on the sets of marks, extend a line from the shroud for about 6" along the tank tubes. Extend the line on the top of the main tube for 7".

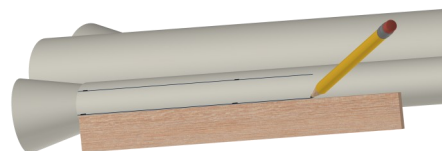

## ATTACH FINS

❑ 21. Apply glue to one of the main fin assemblies and position it along the middle line drawn on one of the tank tubes. Remove it, allow it to almost dry, re-apply glue and reposition it. Allow this fin to dry before proceeding, checking for perpendicular positioning with the main body tube. Repeat with the other main fin assembly on the other tank tube.

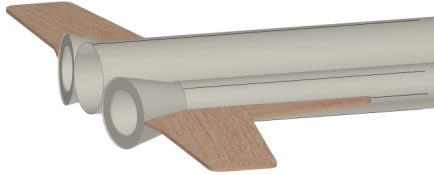

❑ 22. Sight down the end to make sure both fin assemblies are parallel.



❑ 23. Cut each of the wooden dowels (WD-112) to 9.4". Save the small pieces for later. Make sure the top is pointing upward. The top has the line drawn down the center of the main tube. Glue a dowel on the top joint between the main body tube assembly and one of the tank tubes so it is even with the ends of the tank tube. Repeat on the other side. Allow both dowels to dry.

WD-112

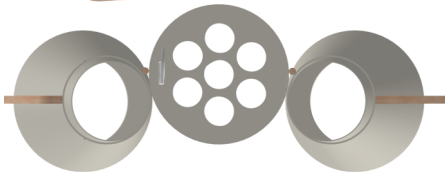

❑ 24. Apply glue to the root edge of one of the rudders and position it on the top line on one of the tank tubes and even with the top of the shroud. Use the alignment guide to get the correct angle. Use the same techniques used on the main fins. Repeat with the other rudder on the other tank tube. Allow both rudders to completely dry using the alignment guide to make sure they remain positioned correctly.

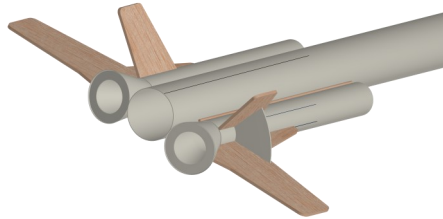
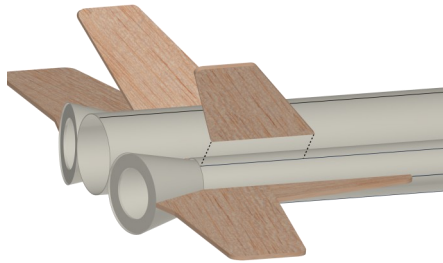

## RAMJETS

❑ 25. Glue one plastic duct (pointed) and one plastic nozzle (PC-5RJ) in one of the jet tubes (ST-525). Recess each 1/16" and run a small bead of glue fillet around the inside of the tube. Repeat with the other five ramjet tubes.

ST-525



❑ 26. Connect three ramjet assemblies together by laying them on a flat surface and running a bead of glue along the joints formed by the tubes. Make sure the tube ends are even and all the nozzles face the same direction. Repeat with the other three ramjets and allow both assemblies to dry.

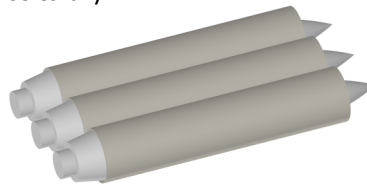

❑ 27. Glue three fiber ramjet supports to the ramjet tubes. Align them with the bottom edge of each support even with the bottom (nozzle) end of each jet tube as shown. Make sure they are all perpendicular to the body tube.

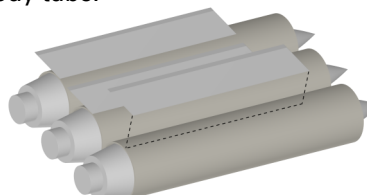

❑ 28. While the supports are drying, sight from one end and make sure they are aligned as shown below. Repeat with the other ramjet assembly.

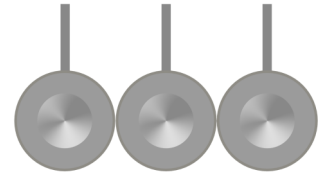

❑ 29. Glue one of the ramjet assemblies to the bottom of one of the wings. Position it so the outer support is about 1-1/4" from the tip of the wing.

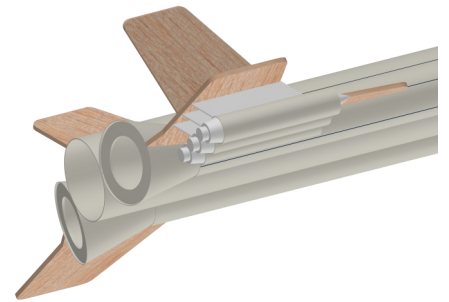

❑ 30. Repeat with the other ramjet assembly on the other wing. Check for alignment as shown below.

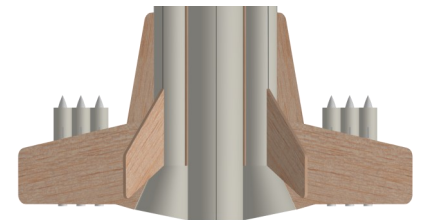

## TANK CONES

❑ 31. Insert one of the small nose cones (BC-1041P) in one of the tank tubes and check for proper fit. If it is too tight, sand the shoulder slightly. Glue the nose cone in place. Repeat with the other small nose cone and the other tank tube. Allow to dry.

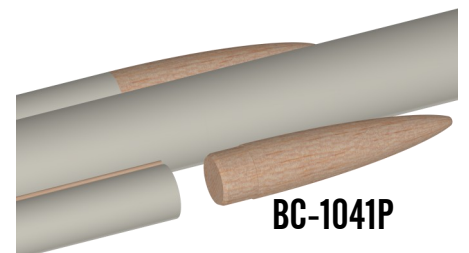

BC-1041P

## ATTACH MOUNT

- ❑ 32. Apply a bead of glue inside the end of the main body tube. Insert the engine mount assembly with the thrust ring end first and engine hook up into the main body tube until the bottom of the engine tube is even with the bottom of the main tube. Do not stop until it is in the correct place. Allow to dry completely in a vertical position. Run a fillet of glue around the bottom ring and the main body tube.

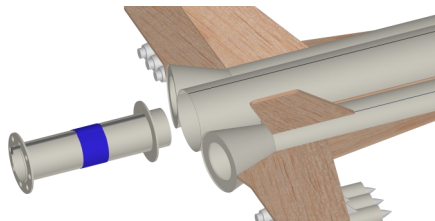

## REAR VANES

- ❑ 33. Apply glue to the root edge of one of the rear vanes and position it on the bottom line on one of the tank tubes and 1/2" from the top of the shroud. Use the alignment guide to get the correct angle. Use the same techniques used on the main fins. Repeat with the other rear vanes on the other tank tube. Allow both rear vanes to completely dry using the alignment guide to make sure they remain positioned correctly.

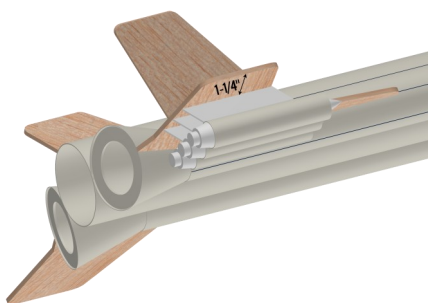

## FORWARD VANE

- ❑ 34. Apply glue to the root edge of the forward vane and center it on the bottom of the main tube assembly and 4" from the top of the tube. Center it by sighting from the front of the tube. When it is dry, add two small dowels on either side of the forward vane and even with the leading edge of the vane. These dowels were left

over from cutting the main dowel supports earlier. Allow to dry.

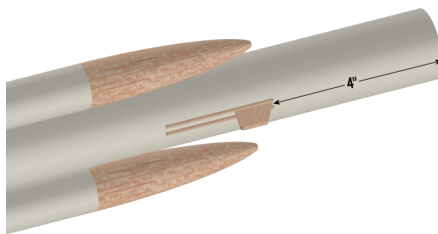

## LAUNCH LUGS

- ❑ 35. Cut the launch lug (LL-320) into two 1" pieces. Using a hobby knife, make a 45 degree cut at each end as shown. Repeat with the other lug.



LL-320

- ❑ 36. Apply a bead of glue to one of the launch lugs and center it on the top of the main body tube assembly and 1-1/2" from the bottom of the tube. Center the other launch lug in line with the first and 6" from the bottom of the tube. Sight from one end to make sure they are parallel with the tube and aligned with each other. Allow to dry.

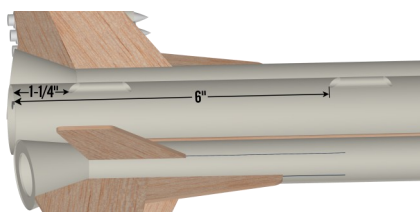

## APPLY FILLETS

- ❑ 37. After the fins and launch lugs are completely dry, run a small bead of glue along both sides of each fin and launch lug-body tube joint. Using your forefinger, smooth the glue into fillets. Apply a fillet of glue on each side of the launch lugs. Allow this assembly to dry in a vertical position.

## NOSE CONE

- ❑ 38. Insert the large nose cone (BC-1655) in the body tube and check for proper fit. The nose cone should be snug to hold itself in alignment. If it is too loose, add masking tape. If it is too tight, sand the shoulder slightly.

- ❑ 39. Screw the screw eye (SE-10) into the base of the large nose cone remove and fill the hole with glue. Reinsert the screw eye until the eye is flush with the base of the nose cone.

SE-10

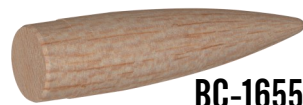

BC-1655



## FINAL ASSEMBLY

- ❑ 40. Assemble the chute (CP-20Y) using instructions provided with it. Pull the lines tight on the chute and make sure they are all of equal length. Attach the chute by tying them to the screw eye. Put a drop of glue on the joint to keep the lines from moving. Attach the free end of the elastic cord to the screw eye. Put a drop of glue on that joint as well.

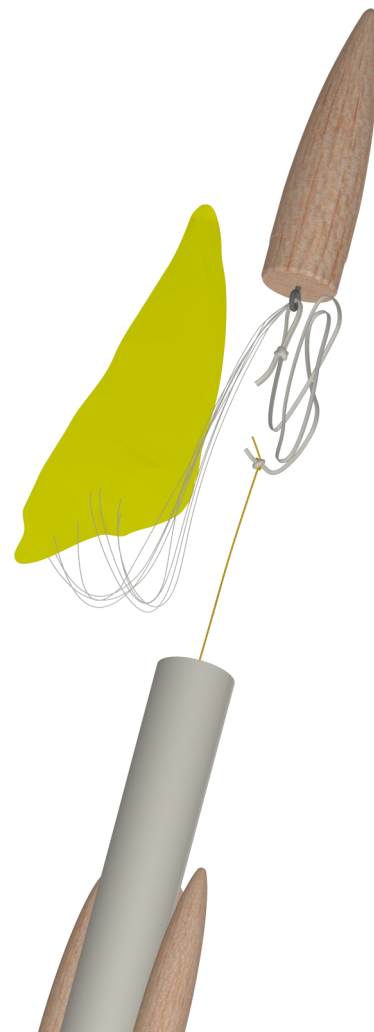

## FINISHING

**41.** When the fillets have dried, prepare balsa surfaces for a smooth professional looking finish. Fill the wood grain with balsa fillercoat or sanding sealer. When dry, sand with fine sandpaper. Repeat until smooth.



1st coat of fillercoat



2nd coat of fillercoat



After 1st sanding



3rd coat of fillercoat



After 1st sanding

**42.** After all balsa surfaces have been prepared, wipe off all balsa dust with a dry cloth. First spray the model with an enamel primer. Choose a high visibility color like white for the final color.

**43.** Spray painting your model with a fast-drying enamel will produce the best results. PATIENCE...is the most important ingredient. Use several thin coats, allowing each coat to completely dry before the next coat. Start each spray a few inches above the model and end a few inches below the model. Keep the can about 12" away and use quick light coats. The final coat can be a little heavier to give the model a glossy wet-looking finish. Use gold paint to detail the plastic ramjet parts.

**44.** After the paint has dried, decals should be applied. The decals supplied with the U.S.S. America™ are waterslide decals. Each decal should be cut separately from the sheet. Think about where you want to apply each decal and check for fit before wetting the decal. Use the last page for suggested placement. **The decal is shipped rolled in the main body tube.**

## FLIGHT PREPPING

**45.** Mounting the engine: Insert the engine and make sure the engine hook keeps the engine in snugly. The hook may be slightly bent to make sure the engine is retained.

**46.** Apply a few sheets of recovery wadding in the top of the main body tube. Fold the parachute and pack it and the shock cord on top of the recovery wadding. Slide the nose cone into place, making sure it does not pinch the shock cord or parachute.

**47.** Refer to the model rocket engine manufacturer's instructions to complete the engine prepping. Different engines have different igniters and methods of hooking them up to the launch controllers.

**48.** Carefully check all parts of your rocket before each flight as a part of your pre-flight checklist. Launch the U.S.S. America™ from a 3/16" diameter by 36" long launch rod.

**49.** After each flight, promptly remove the spent engine casing and dispose of properly.

## Decal Instructions

1. Allow all paint to completely dry.
2. Cut out each decal as needed.
3. Dip decal in water for about 30 seconds.
4. Slide decal from backing paper in its position.
5. Use backing paper to remove air bubbles.

## Notes

1. Wrap the three vane (green) decals around the leading edges of the vanes.
2. Place the red USA decals on inside of the rudders and the blue USA decals on the outside of the rudders.

