

## About Semroc Astronautics Corporation

Semroc Astronautics Corporation was started by Carl McLawhorn in his college dorm at North Carolina State University in November, 1967. Convincing a small group of investors in his home town of Ayden, North Carolina to invest in a small corporation, the company was re-incorporated as Semroc Astronautics Corporation on December 31, 1969.

Semroc produced a full line of model rocket kits and engines. At its peak, Semroc had twenty-five full time employees working at two facilities. One was for research and development, printing, shipping, and administration. The other was outside town and handled all production and model rocket engine manufacturing. For several years, Semroc was successful selling model rocket kits, supplies, and engines by mail-order and in hobby shops. In early 1971, Semroc became insolvent and had to close its doors.

After 31 years of dreams and preparations, Semroc Astronautics Corporation was reincorporated on April 2, 2002 with a strong commitment to helping put the fun back into model rocketry.

## About the IRIS™

The Iris was designed by Atlantic Research Corporation and was transferred to NASA. The first flight was July 22, 1960 at Wallops Island, Virginia. It was designed to loft 100 pounds to an altitude of 200 miles. It was flown with a booster consisting of a cluster of seven very short burn motors that dropped off before the tower was cleared. Of the four flights between 1960-1962, only the first two were fully successful. At least six more flights used the Iris as an upper stage in a joint Navy-Lawrence Livermore National Laboratory project named Hydra Iris, that used three Sparrow motors as the booster and was launched from under water.

## About Deci-Scale™

Semroc's new line of Deci-Scale™ models includes 1/10 (deci) scale kits of many of the early sounding rockets. The Deci-Scale™ kits are intended to be fun to build, providing the beginning average modeler with all the parts needed to build a reasonably close scale model. An advanced scale modeler will find the included parts are very close to the exact scale that are needed for much closer models.

The Deci-scale™ line was inspired by G. Harry Stine who said, "the best beginner's scale model I've ever found is the Thiokol-NASA I.Q.S.Y Tomahawk." He designed a 1/10 scale model for Centuri Engineering Company that was very popular and sold for many years. As he and others have found, 1/10 scale is almost perfect for many of the favorite rockets and missiles of the early days of space flight.

August 5, 2009

Copyright © 2009 Semroc Astronautics Corporation  
Box 1271 Knightdale, NC 27545 (919) 266-1977

# IRIS

**1/10 SEMI-SCALE  
MODEL**

**ALMOST 2 FEET  
TALL**

**EASY TO BUILD  
& FUN TO FLY**

**FLYING MODEL  
ROCKET KIT**

**DECI/SCALE**

**LASER CUT FINS**

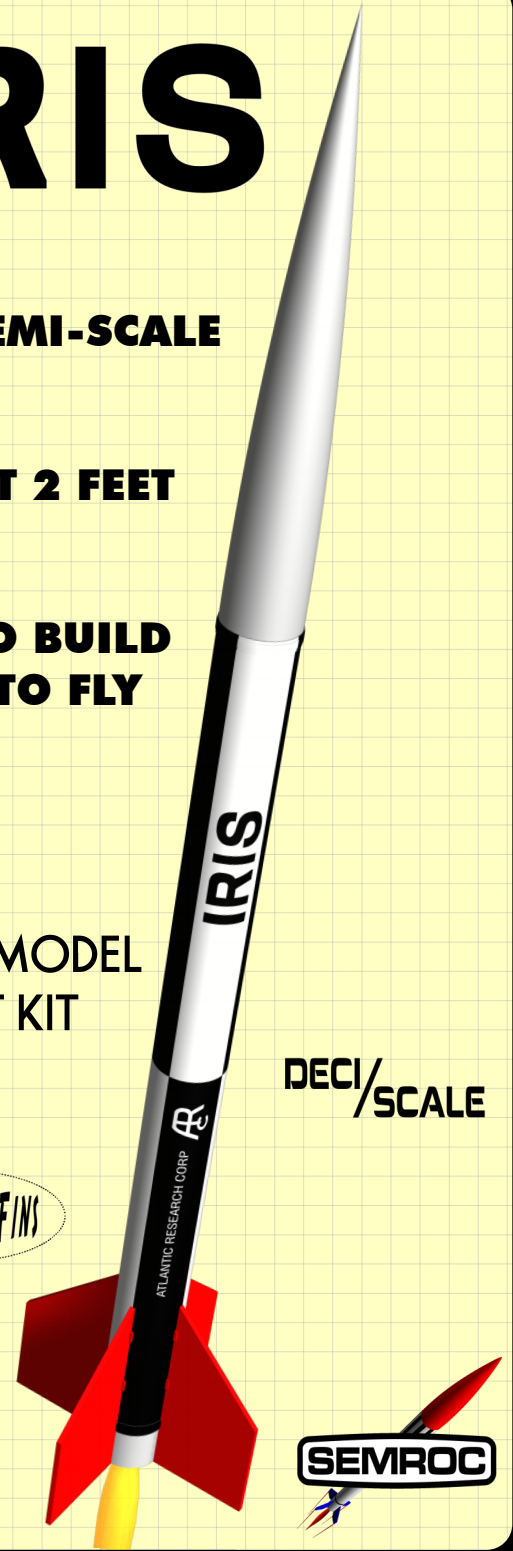

Made in the U.S.A by Semroc Astronautics Corporation - Knightdale, N.C. 27545

## IRIS™ Kit No. KD-4

	Specifications	Engine	Approx. Altitude
Body Diameter	1.17" (3.0 cm)	A8-3	200'
Length	23.8" (60.4 cm)	B6-4	450'
Fin Span	4.7" (11.9 cm)	C6-5	950'
Net Weight	1.3 oz. (36.9 g)		

**PARACHUTE RECOVERY**

# Parts List

# EXPLODED VIEW

- A 1 Balsa Nose Cone... BC-1180
- B 1 Body Tube..... ST-11158
- C 1 Body Tube..... ST-730E
- D 1 Laser Cut Fins ..... FD-4
- E 1 Ring Set ..... CR-KD-4
- F 1 Chute Pak..... CP-12RY
- G 1 Shock Cord ..... SCK-18
- H 1 Elastic Cord..... EC-124
- I 1 Screw Eye ..... SE-12
- J 2 Launch Lugs ..... LL-2AM
- K 1 Engine Hook ..... EH-28
- L 1 Thrust Ring ..... TR-7
- M 1 Decals (Set of 2).... DKD-4
- N 1 Bands (Set of 2) .... IKD-4S

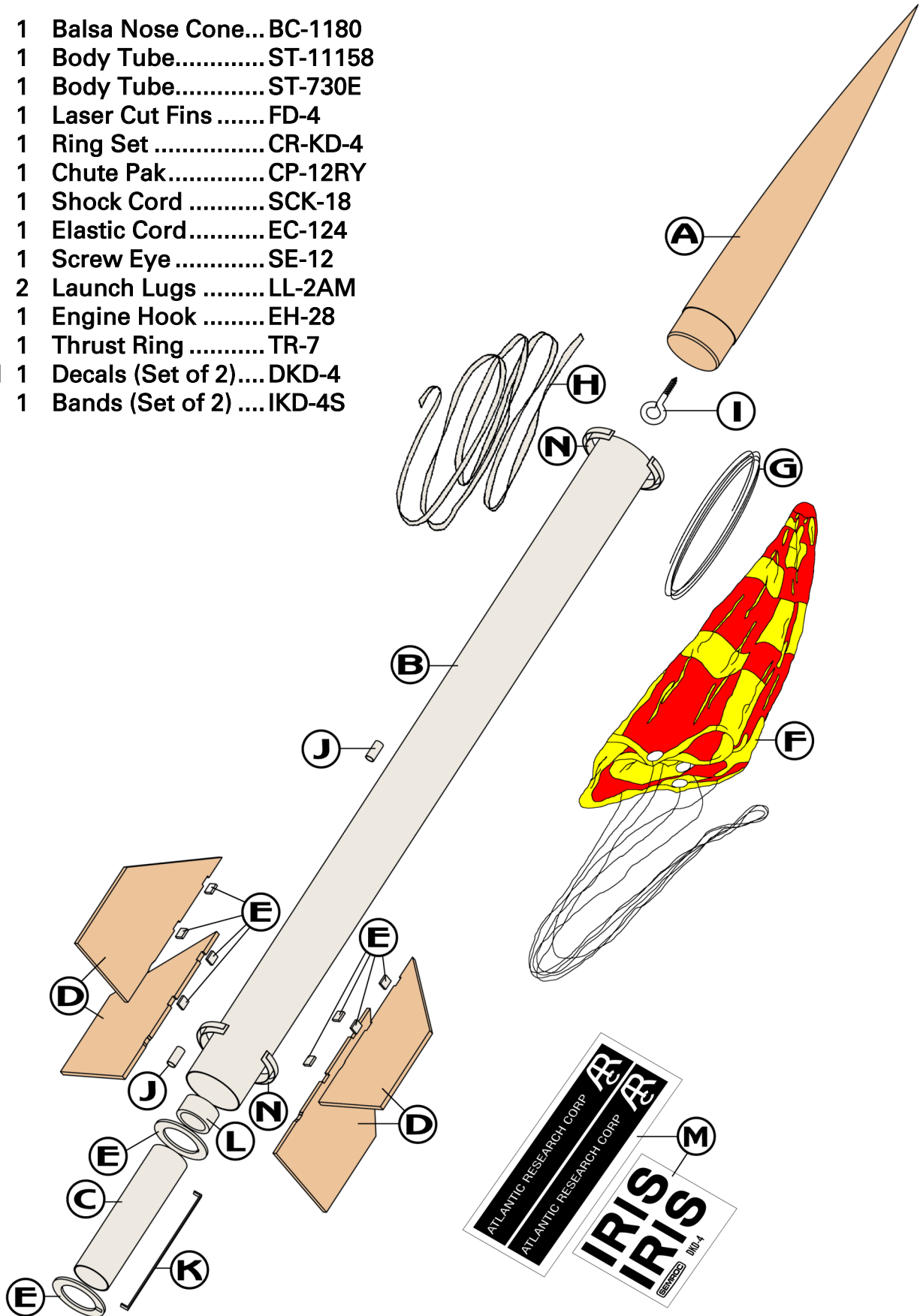

## BEFORE YOU START!

Make sure you have all the parts included in this kit that are listed in the Parts List. In addition to the parts included in this kit, you will also need the tools and materials listed below. Read the entire instructions before beginning to assemble your rocket. When you are thoroughly familiar with these instructions, begin construction. Read each step and study the accompanying drawings. Check off each step as it is completed. In each step, test-fit the parts together before applying any glue. It is sometimes necessary to sand lightly or build-up some parts to obtain a precision fit. If you are uncertain of the location of some parts, refer to the exploded view. It is important that you always ensure that you have adequate glue joints.

## TOOLS

In addition to the parts supplied, you will need the following tools to assemble and finish this kit. Masking tape is also needed.



## ASSEMBLY

1. These instructions are presented in a logical order to help you put your Iris™ together quickly and efficiently. Check off each step as you complete it and we hope you enjoy putting this kit together.

## FIN PREPARATION

2. Lightly sand each side of the laser-cut fin sheet (FD-4). Carefully push the laser-cut fins from the sheet. Start at one point on each fin and slowly and gently work around the fin.

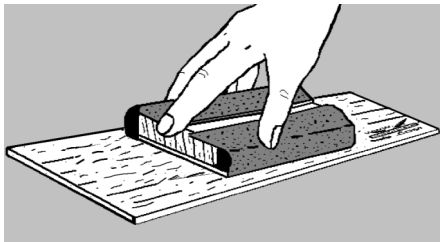

3. Stack all four fins in a group. Line the group up squarely and sand the fins back and forth over some fine sandpaper to get rid of the hold-in tabs as shown below. Sand the root edge *very gently*.

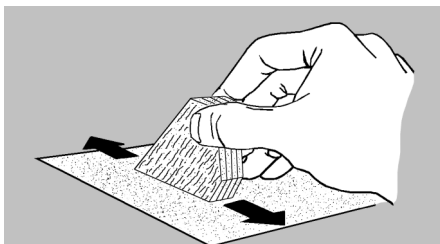

4. Sand a taper on each leading edge and trailing edge and leave all the tip and root edges flat.

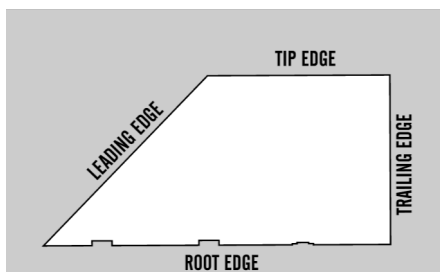

## ENGINE MOUNT

5. Bend the engine hook (EH-28) slightly so it forms a slight bow in the direction shown.

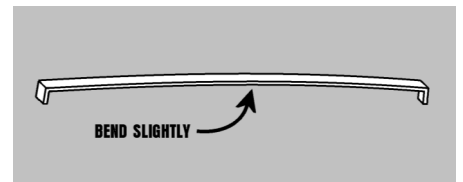

6. Tie a loop in one end of the yellow Kevlar® cord (SCK-18). Insert one end of the engine hook (EH-28) through the loop and into the pre-punched engine tube (ST-730E).

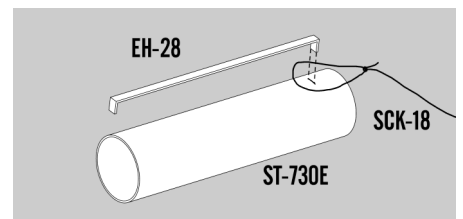

7. Apply a small bead of glue around the inside of the engine tube nearest the punched end. Slide the thrust ring (TR-7) into the tube and against the engine hook.

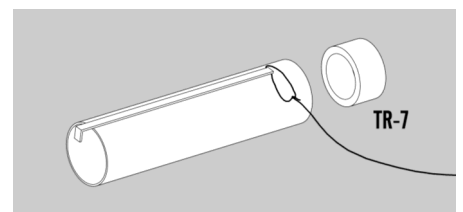

8. Slide the centering ring with the small notch (CR-KD-4A) over the engine tube until it is against the Kevlar cord. Apply a bead of glue around each end of the joint between the ring and engine tube, keeping glue off the outside surface of the centering ring. Allow to dry.

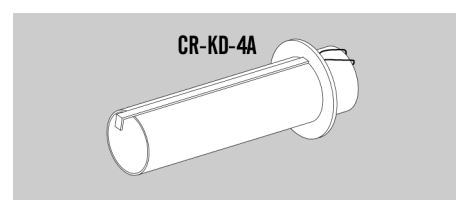

❑ 9. Add one wrap of masking tape around the center of the assembly to hold the engine hook in place. Apply a bead of glue over the masking tape and along the edges of the engine hook between the tape and the centering ring. Keep glue off the free end of the engine hook.

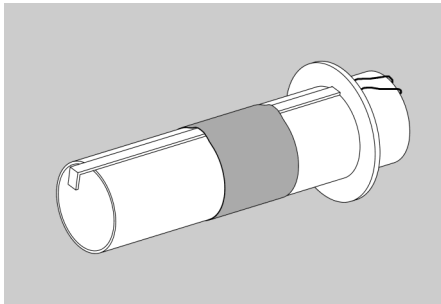

❑ 10. Slide the centering ring with the long slot (CR-KD-4B) over the end of the engine tube. Space it about 1/16" from the bottom of the engine tube. Apply a bead of glue around both sides of the centering ring, keeping glue away from the engine hook and the notch.

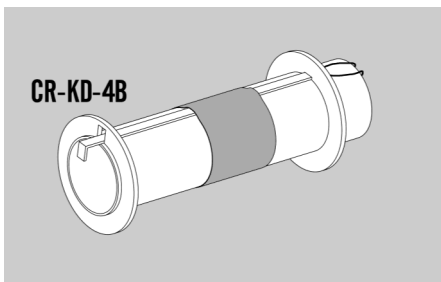

## BODY TUBE

❑ 11. Stand the main body tube (ST-11158) on the fin guide above and mark the fin position marks on the sides of the tube. Find a convenient channel or groove such as a partially open drawer, a door jamb (as shown,) or a piece of molding. Using the channel, extend the marks the full length of the tube to provide lines for aligning the fins.

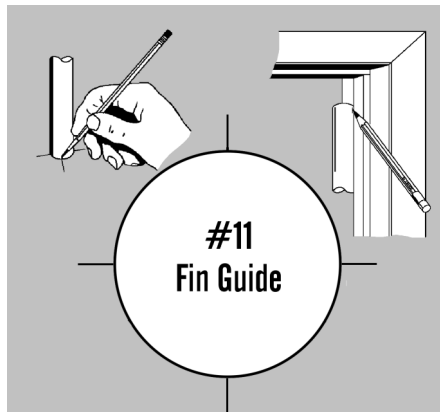

## INSERT MOUNT

❑ 12. Check the engine mount for fit in the lower (marked) body tube. If it has rough edges or excessive glue, sand lightly until it fits into the body tube. Apply a heavy bead around the inside of the body tube.

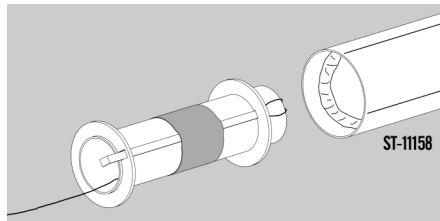

❑ 13. Quickly and smoothly push the engine mount into the marked end of the body tube until about it is even with the bottom of the body tube and the **engine hook is centered between two of the lines**. Do not stop once you start inserting the mount or it might freeze in place too soon.

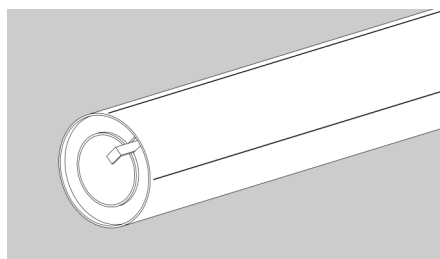

## FIN MOUNTS

❑ 14. Punch out the eight fin mounts from the centering ring set. Glue two on each fin root edge, centering the mounts on the fin. The longest side of the fin mount should be parallel with the fin. Use glue sparingly.

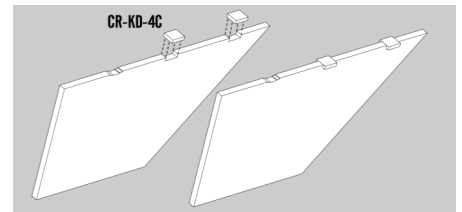

## ATTACH BANDS

❑ 15. Use one of the fin assemblies to mark the location of the bottom ring. Holding the end of the root edge even with the end of the body tube and along one of the marked lines, place a mark at each end of the notch. This will provide clearance for the bands.

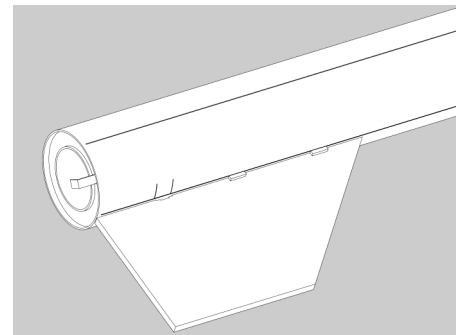

❑ 16. Apply a very thin bead of glue to the dull side of one of the bands (IKD-4S) on the widest half. Starting the wide end on the marked fin line and even with the two marks, carefully wrap the first half of the band around the body tube. The wide ends should meet at the fin line.

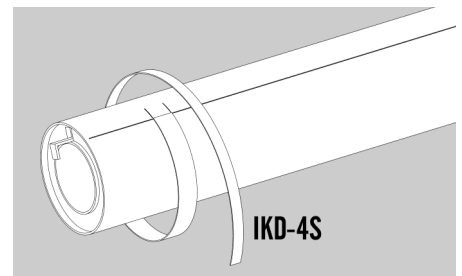

❑ 17. Apply a very thin bead of glue to the dull side of the narrow end and continue wrapping the rest of the band around the body tube, centering the narrow strip over the wide portion. The end should also meet over the previous joint.

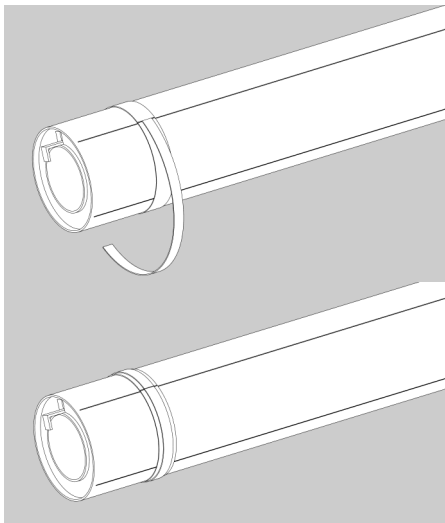

❑ 18. Apply a very thin bead of glue to the dull side of the other band on the widest half. Starting the wide end on the same marked fin line as the lower band, and even with the top of the body tube, apply the band the same as the lower band.

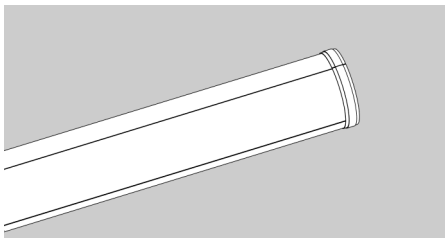

## ATTACH FINS

❑ 19. Apply glue to the root edge of one of the fins and position it along one of the lines drawn for the fins on the side of the body tube and even with the end of the tube. The notch in the fin should be centered over the band. Remove, allow to almost dry, apply additional glue, and reposition. Repeat for the other three fins. Allow to dry in an upright position, checking frequently to make sure they remain aligned.

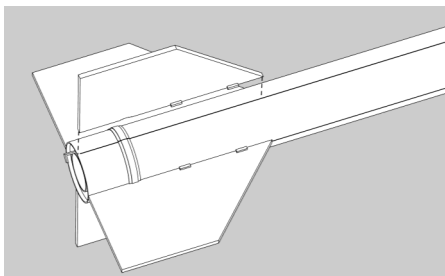

❑ 20. After the fin assembly is completely dry, run a very small bead of glue along both sides of each fin-body tube joint. Using your forefinger, smooth the glue into fillets. Since this is a scale model, it should not have fillets showing. Wipe any excess glue and allow to dry.

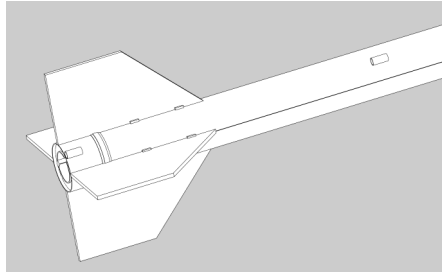

## LAUNCH LUGS

❑ 21. Glue one of the launch lugs (LL-2AM) between two of the fins and even with the bottom of the main body tube. Glue the second launch lug about 5" above the lower lug and in line with it. Sight down the tube to make sure both lugs are aligned and parallel with the main body tube.

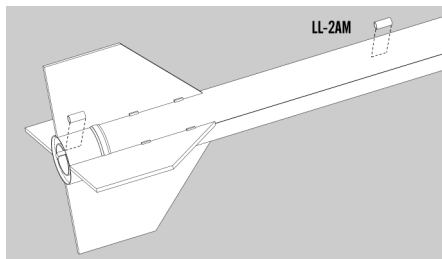

## NOSE CONE

❑ 22. Insert the nose cone (BC-8460) in the top of the body tube and check for proper fit. The nose cone should be snug to hold itself in alignment. If it is too loose, add some masking tape. If it is too tight, sand the shoulder slightly.

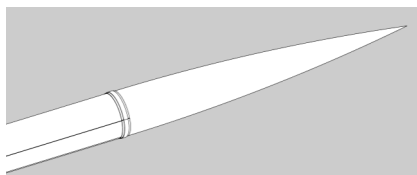

❑ 23. Twist the screw eye (SE-12) into the center of the base of the nose cone. Remove it and squirt a drop of glue into the hole. Reinsert the screw eye and run a bead of glue around the shaft against the nose cone.

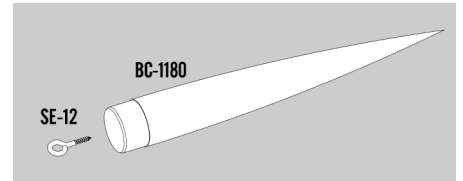

## SHOCK CORD

❑ 24. Prepare the shock cord as follows. Line up one end of the elastic shock cord (EC-124) with the free end of the Kevlar cord (SCK-18) and tie an overhand knot at the end of the two cords. Pull the knot tight and place a small drop of white glue on the knot to prevent it from loosening.

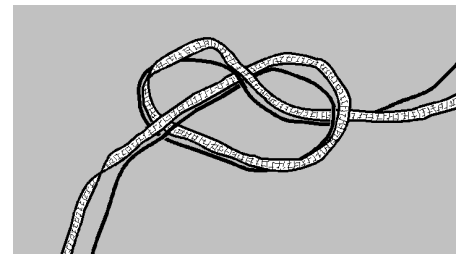

## FINAL ASSEMBLY

❑ 25. Assemble the chute (CP-12RY) using the instructions that come with the Chute Pak. Pull the lines tight on the chute and make sure they are all of equal length. Attach the chute by tying them to the screw eye. Put a drop of glue on the joint to keep the lines from moving. Shake the elastic cord free and out of the top of the main tube. Attach the free end of the elastic cord to the screw eye. Put a drop of glue on that joint as well.

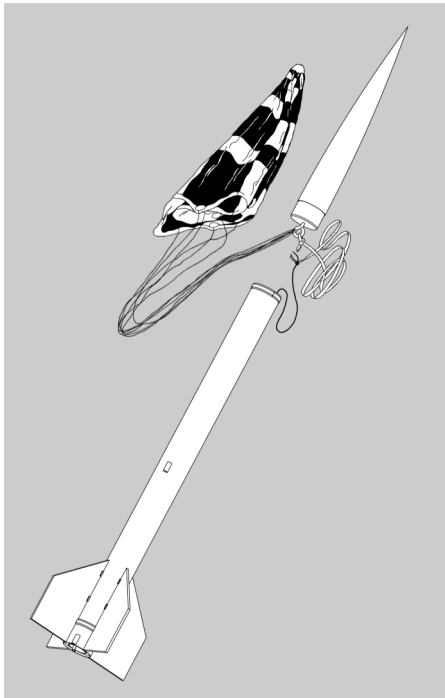

This completes the assembly of your  
**IRIS**

**FINISHING**

**26.** For a smooth professional looking finish, fill the wood grain with balsa fillercoat or sanding sealer. When dry, sand with fine sandpaper. Repeat until smooth.

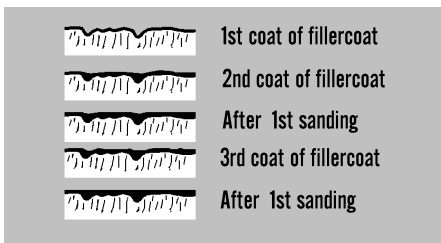

**27.** After all balsa surfaces have been prepared, wipe off all balsa dust with a dry cloth. First spray the model with an enamel primer. Choose a high visibility color like white for the final color. Refer to the front for suggested (scale) painting.

**28.** Spray painting your model with a fast-drying enamel will produce the best results. PATIENCE...is the most important ingredient. Use several thin coats, allowing each coat to completely dry before the next coat. Start each spray a few inches above the model and end a few inches below the model. Keep the can about 12" away and use quick light coats. The final coat can be a little heavier to give the model a glossy wet-looking finish.

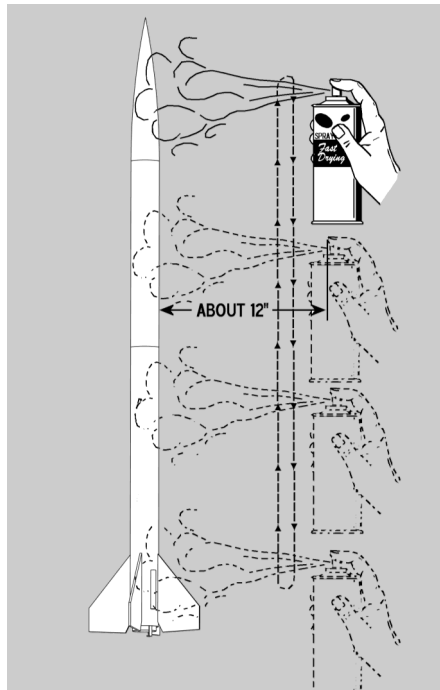

**29.** After the paint has dried, decals should be applied. The decals supplied with the Iris™ are waterslide decals. Each decal should be cut separately from the sheet. Think about where you want to apply each decal and check for fit before wetting the decal. Use the cover photo for suggested placement. Dip each decal in a small dish of water that has a drop of detergent. It will take about 30 seconds before the decal is loose enough to apply.



**30.** Slide the decal in place and use the paper backing to work the bubbles out. Repeat for all the decals.

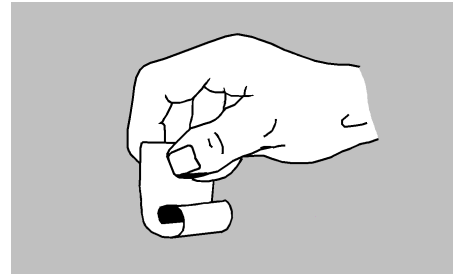

**FLIGHT PREPPING**

**31.** Mounting the engine: Insert the engine and make sure the engine hook keeps the engine in snugly. The hook may be slightly bent to make sure the engine is retained.

**32.** Apply a few sheets of recovery wadding in the top of the body tube. Fold the parachute and pack it and the shock cord on top of the recovery wadding. Slide the nose cone into place, making sure it does not pinch the shock cord or parachute.

**33.** Refer to the model rocket engine manufacturer's instructions to complete the engine prepping. Different engines have different igniters and methods of hooking them up to the launch controllers.

**34.** Carefully check all parts of your rocket before each flight as a part of your pre-flight checklist. Launch the Iris™ from a 1/8" diameter by 36" long launch rod.

**35.** After each flight, promptly remove the spent engine casing and dispose of properly.