



Model Rocket Safety Code

- 1. Materials.** I will use only lightweight, non-metal parts for the nose, body, and fins of my rocket.
- 2. Motors.** I will use only certified, commercially-made model rocket motors, and will not tamper with these motors or use them for any purposes except those recommended by the manufacturer.
- 3. Ignition System.** I will launch my rockets with an electrical launch system and electrical motor igniters. My launch system will have a safety interlock in series with the launch switch, and will use a launch switch that returns to the "off" position when released.
- 4. Misfires.** If my rocket does not launch when I press the button of my electrical launch system, I will remove the launcher's safety interlock or disconnect its battery, and will wait 60 seconds after the last launch attempt before allowing anyone to approach the rocket.
- 5. Launch Safety.** I will use a countdown before launch, and will ensure that everyone is paying attention and is a safe distance of at least 15 feet away when I launch rockets with D motors or smaller, and 30 feet when I launch larger rockets. If I am uncertain about the safety or stability of an untested rocket, I will check the stability before flight and will fly it only after warning spectators and clearing them away to a safe distance.
- 6. Launcher.** I will launch my rocket from a launch rod, tower, or rail that is pointed to within 30 degrees of the vertical to ensure that the rocket flies nearly straight up, and I will use a blast deflector to prevent the motor's exhaust from hitting the ground. To prevent accidental eye injury, I will place launchers so that the end of the launch rod is above eye level or will cap the end of the rod when it is not in use.
- 7. Size.** My model rocket will not weigh more than 1,500 grams (53 ounces) at liftoff and will not contain more than 125 grams (4.4 ounces) of propellant or 320 N-sec (71.9 pound-seconds) of total impulse. If my model rocket weighs more than one pound (453 grams) at liftoff or has more than four ounces (113 grams) of propellant, I will check and comply with Federal Aviation Administration regulations before flying.
- 8. Flight Safety.** I will not launch my rocket at targets, into clouds, or near airplanes, and will not put any flammable or explosive payload in my rocket.
- 9. Launch Site.** I will launch my rocket outdoors, in an open area at least as large as shown in the accompanying table, and in safe weather conditions with wind speeds no greater than 20 miles per hour. I will ensure that there is no dry grass close to the launch pad, and that the launch site does not present risk of grass fires.
- 10. Recovery System.** I will use a recovery system such as a streamer or parachute in my rocket so that it returns safely and undamaged and can be flown again, and I will use only flame-resistant or fireproof recovery system wadding in my rocket.
- 11. Recovery Safety.** I will not attempt to recover my rocket from power lines, tall trees, or other dangerous places.

LAUNCH SITE DIMENSIONS

Installed Total Impulse (N-sec)	Equivalent Motor Type	Minimum Site Dimensions (ft.)
0.00 — 1.25	1/4A	50
1.26 — 2.50	A	100
2.51 — 5.00	B	200
5.01 — 10.00	C	400
10.01 — 20.00	D	500
20.01 — 40.00	E	1000
40.01 — 80.00	F	1000
80.01 — 160.00	G	1000
160.01 — 320.00	2 Gs	1500

BATROK

GREAT BEGINNER KIT

CLEAR PAYLOAD SECTION

FUN TO BUILD AND FLY

FLYING MODEL ROCKET KIT

1967
Orbit Repro
Designed by:
Ron Maggiano

LASER CUT FINS

SEMROC

Rev B

Made in the U.S.A by Semroc Astronautics Corporation - Knightdale, N.C. 27545

BATROK™ Kit No. KV-53

Specifications	Engine	Approx. Altitude
Body Diameter 0.759" (1.9 cm)	A8-5	400'
Length 12.0" (30.5 cm)	B6-6	800'
Fin Span 4.0" (10.2 cm)	C6-7	1300'
Net Weight 0.6 oz. (15.9 g)		

PARACHUTE RECOVERY

What is a Retro-Repro™ ?

A Retro-Repro™ is a retro reproduction of an out-of-production model rocket kit. It is a close approximation of a full scale model of an early historically significant model rocket kit from one of the many companies that pioneered the hobby over the past half century. A Retro-Repro™ is not a true clone or identical copy of the original. It incorporates improvements using modern technology, while keeping the flavor and build appeal of the early kits.

About

Centuri Engineering Company

Centuri Engineering Company was started in 1961 by Leroy (Lee) Piester in his garage while he was still in college in Phoenix, Arizona. With his wife, Betty, they built Centuri into one of the largest model rocket companies ever.

Centuri was known for its unusual and innovative designs, producing over 140 different kits with something for every model rocketeer. They also produced model rocket engines and pioneered the modern composite high powered engines with their Enerjet line.

Centuri Engineering was sold to Damon in the late 1960's and shared the same parent corporation with Estes Industries, the largest model rocket company in the world. The Centuri product line was kept separate from the Estes line until 1983. A few of the old kits have been reissued by Estes since then, but for the most part, Centuri Engineering Company lives today only in the dreams of the senior members of the model rocket community.

March 6, 2005
Revised May 1, 2005

Copyright © 2005 Semroc Astronautics Corporation
Box 1271 Knightdale, NC 27545 (919) 266-1977

LIMITATION OF LIABILITY

Model rockets are not toys, but are functional rockets made of lightweight materials and are launched with NAR or Tripoli safety certified model rocket motors, electrically ignited and flown in accordance with the NAR Model Rocket Safety Code. If misused, model rockets can cause serious injury and property damage. Semroc certifies that it has exercised reasonable diligence in the design and manufacture of its products. Semroc cannot assume any liability for the storage, transportation, or usage of its products. Semroc shall not be held responsible for any personal injury or property damage whatsoever arising out of the handling, storage, use, or misuse of our products. The buyer assumes all risks and liabilities therefrom and accepts and uses Semroc products on these conditions.

Your purchase and use of any Semroc products is construed as your agreement to and acceptance of these terms. If you do not agree to these terms and conditions, you must return the product, unused, for refund or credit.

100% SATISFACTION GUARANTEE

If you are not 100% satisfied with your Semroc product, we will make it right by providing whatever you consider fair, from refund to replacement.

Contact us at:

Semroc Astronautics Corporation
Customer Service Department
P.O. Box 1271
Knightdale, North Carolina 27545

JOIN THE NAR!

Sign up online at www.nar.org to join the premier model rocketry organization. Semroc fully supports the National Association of Rocketry and recognizes it as the sport's official voice. The NAR is the oldest and largest sport rocketry organization in the world. Since 1957 over 80,000 serious sport rocket modelers have joined the NAR to take advantage of the fun and excitement of organized rocketry. It is always more fun if you fly with friends. The *Sport Rocketry* magazine is one of the best ways to keep informed of new developments in the hobby. Check online at www.semroc.com/nar for promotions just for NAR members.



FLIGHT PREPPING

- ❑ **25.** Mounting the engine: Pull the black Kevlar® cord out of the back of the body tube. Wrap a small piece of masking tape around the end of the engine. While holding the shock cord tightly, press the engine into the body tube until it is against the thrust ring.

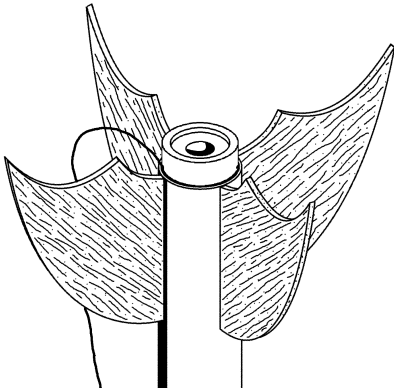

- ❑ **26.** Pack the recovery wadding from the top of the body tube. Use a sufficient quantity to protect the parachute, but not too much that it will interfere with the proper deployment of the parachute.

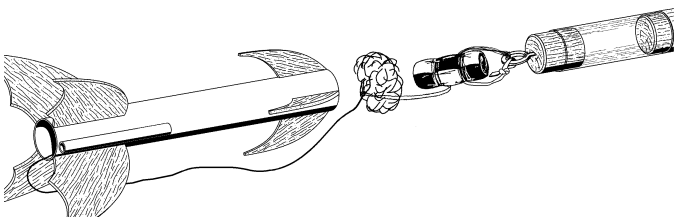

- ❑ **27.** Fold the parachute and pack it and the shock cord on top of the recovery wadding. Slide the nose cone into place, making sure it does not pinch the shock cord or parachute. The Black Kevlar® cord will fit against the outside of the body tube.

- ❑ **28.** Refer to the model rocket engine manufacturer's instructions to complete the engine prepping. Different engines have different igniters and methods of hooking them up to the launch controllers.

- ❑ **29.** Carefully check all parts of your rocket before each flight as a part of your pre-flight checklist. Launch the BatRok™ from a 1/8" diameter by 36" long launch rod.

About the BatRok™

The BatRok™ was introduced in 1967 by Centuri Engineering Company in their *American Rocketeer*. It was designed by Ron Maggiano while he was a high school student in Scottsdale, Arizona. Inspired by the hit television series *Batman* which premiered in 1966, Ron entered his original design in a model rocket competition sponsored by Centuri and won a \$25.00 gift certificate. The original BatRok™ was slightly smaller but had the distinctive "Bat-Fins" and payload compartment. Although the BatRok™ did not make it into a catalog, it is an outstanding example of the innovativeness of early modelers. The BatRok™ was Centuri #KB-8 and was introduced with a price of \$1.95.

The Retro-Repro™ BatRok™ is updated by using laser-cut fins. The original balsa nose cone and body tube sizes are used. The original rubber shock cord is replaced with an elastic cord for longer life. The original method of slitting the body tube to anchor the shock cord has been replaced by a Kevlar® cord for greater reliability.

BEFORE YOU START!

Make sure you have all the parts included in this kit that are listed in the Parts List in the center of these instructions. In addition to the parts included in this kit, you will also need the tools and materials listed below. Read the entire instructions before beginning to assemble your rocket. When you are thoroughly familiar with these instructions, begin construction. Read each step and study the accompanying drawings. Check off each step as it is completed. In each step, test-fit the parts together before applying any glue. It is sometimes necessary to sand lightly or build-up some parts to obtain a precision fit. If you are uncertain of the location of some parts, refer to the exploded view in the center of these instructions. It is important that you always ensure that you have adequate glue joints.

TOOLS: In addition to the parts supplied, you will need the following tools to assemble and finish this kit.



ASSEMBLY

- ❑ **1.** These instructions are presented in a logical order to help you put your BatRok™ together quickly and efficiently. Check off each step as you complete it and enjoy putting this kit together.

SHOCK CORD MOUNT

- ❑ **2.** Prepare the shock cord as follows. Line up one end of the elastic shock cord with one end of the black Kevlar® cord and tie an overhand knot at the end of the two cords. Pull the knot tight and place a small drop of white glue on the knot to prevent it from loosening.

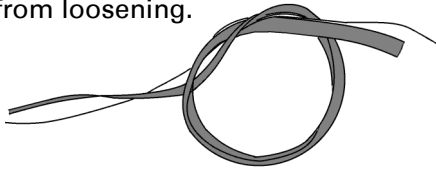

- ❑ **3.** Tie the other end of the black Kevlar® cord to the thrust ring. Place the elastic cord and Kevlar® cord through the spacing tube. The thrust ring is to be glued 2 1/2" from the end of the body tube. Mark the engine spacing tube 1/4" from the end away from the thrust ring.

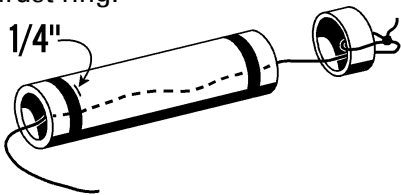

- ❑ **4.** Put a large dab of glue on your little finger or a cotton-tipped swab and spread the glue around inside the body tube as far as your finger (or swab) will reach, but no farther than 2 1/2". Try not to get any glue close to the end of the tube. Insert the thrust ring just inside the end of the body tube making sure the Kevlar® cord and elastic shock cord are pulled out of the back of the engine spacing tube. Use the spacing tube to push the thrust ring until the mark on the casing is even with the end of the body tube. CAUTION: Once you have started to push, do not stop or the ring will "freeze" in place. Remove the spacing tube immediately and discard.

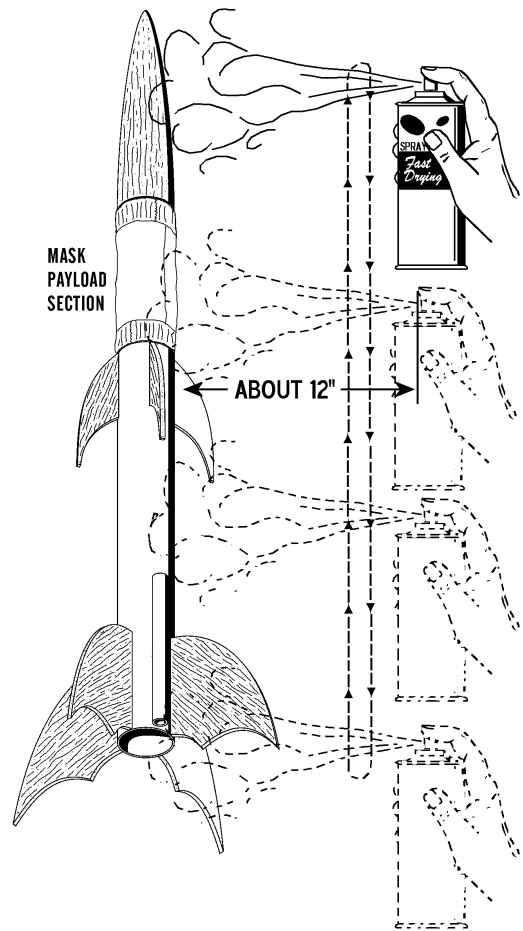
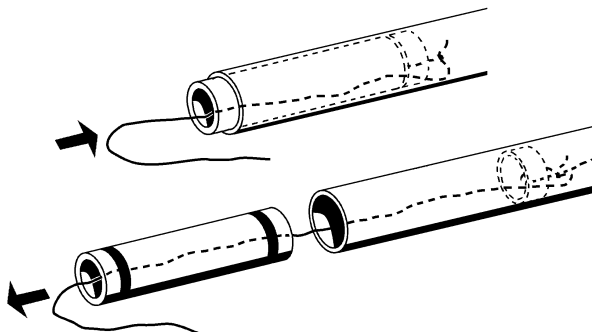

- ❑ **24.** After the paint has dried, decals should be applied. The decals supplied with the BatRok™ are waterslide decals. Each decal should be cut separately from the sheet. Completely apply one of the decals before starting the next. Think about where you want to apply each decal and check for fit before wetting the decal. Make sure the ends are aligned with the roll pattern.

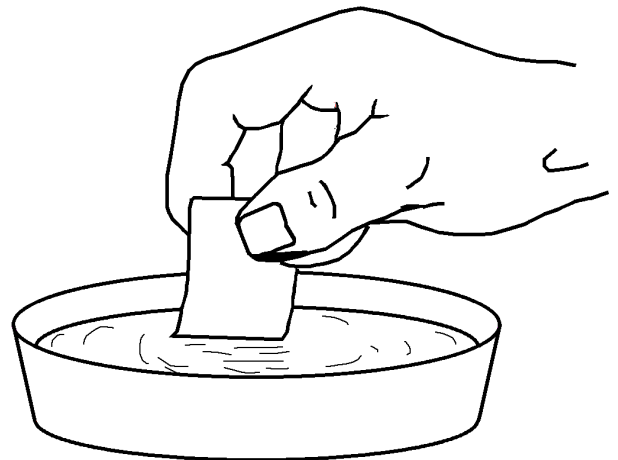

FINISHING

- 21.** When the fillets have dried, prepare balsa surfaces for a smooth professional looking finish. Fill the wood grain with balsa fillercoat or sanding sealer. When dry, sand with fine sandpaper. Repeat until smooth.

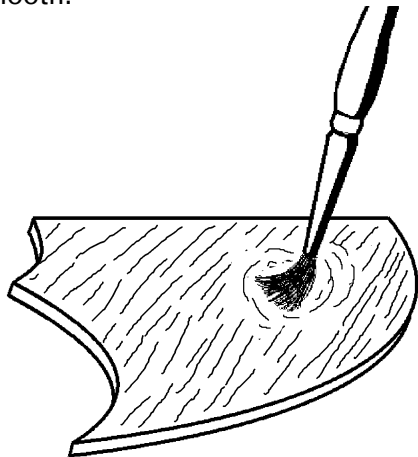

1st coat of fillercoat



2nd coat of fillercoat



After 1st sanding



3rd coat of fillercoat



After final sanding

- 22.** After all balsa surfaces have been prepared, wipe off all balsa dust with a dry cloth. First spray the model with an enamel primer. Paint the BatRok™ a dark gray to match the cover colors. The decals are black, so a dark gray will give you just the right contrast for the "Gotham" look.

- 23.** Spray painting your model with a fast-drying enamel will produce the best results. PATIENCE...is the most important ingredient. Use several thin coats, allowing each coat to completely dry before the next coat. Start each spray a few inches above the model and end a few inches below the model. Keep the can about 12" away and use quick light coats. The final coat can be a little heavier to give the model a glossy wet-looking finish. Use rolled newspaper to hold the rocket while you spray the model.

PREP FINS

- 5.** Lightly sand each side of the laser-cut fins. Carefully push the laser-cut fins from their sheet. Start at one point on each fin and slowly and gently work around each fin.

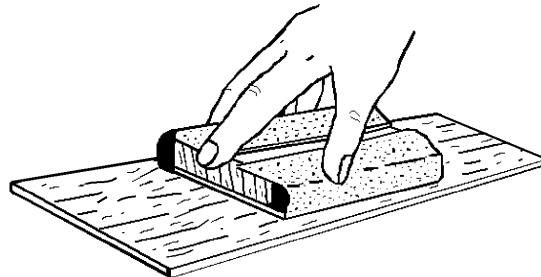

- 6.** Stack the fins in two sets of four and line them up squarely. Run the fins back and forth over some fine sandpaper to get rid of the hold-in tabs as shown below.

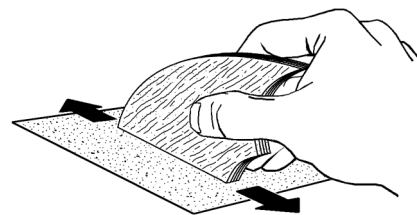

- 7.** Round all edges except the root edge. The root edge should remain flat since it will be glued to the body tube. Since the BatRok™ has so many concave edges it will be necessary to sand some edges individually.

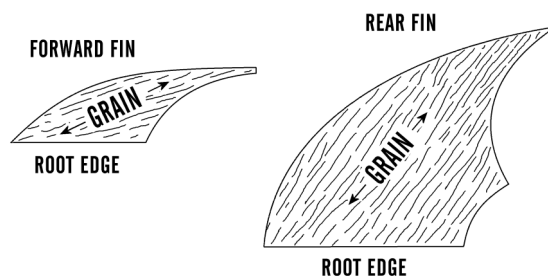

- 8.** Stand the body tube on the fin guide below and make all eight fin position marks on the sides of the tube. Find a convenient channel or groove such as a partially open drawer, a door jamb (as shown,) or a piece of molding. Using the channel, extend the marks the full length of the tube to provide lines for aligning the fins.



FIN ASSEMBLY

- ❑ 9. Apply glue to the root edge of one of the rear (larger) fins and position it along one of the lines drawn on the side of the body tube. Remove, allow to dry, apply additional glue, and reposition. Repeat for other three fins using every other line drawn in the previous step.

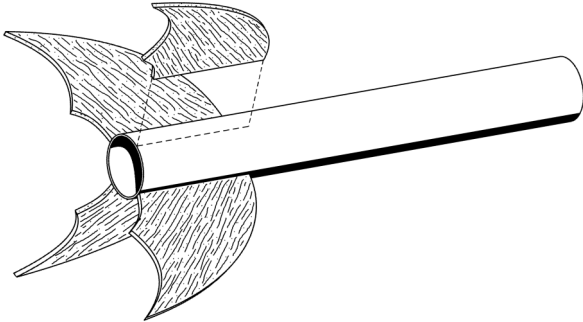

- ❑ 10. Allow to dry standing vertically, checking for alignment visually while the assembly dries. Stuff the shock cord and Kevlar® cord into the body tube so it will remain vertical. Refer to the end view below for correct placement.

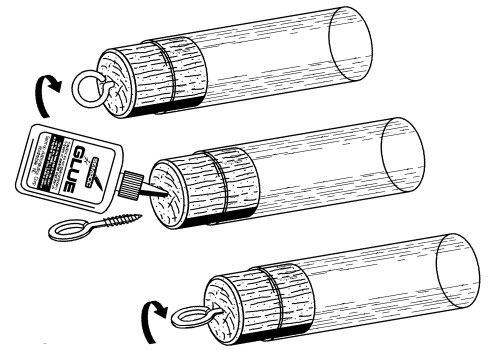
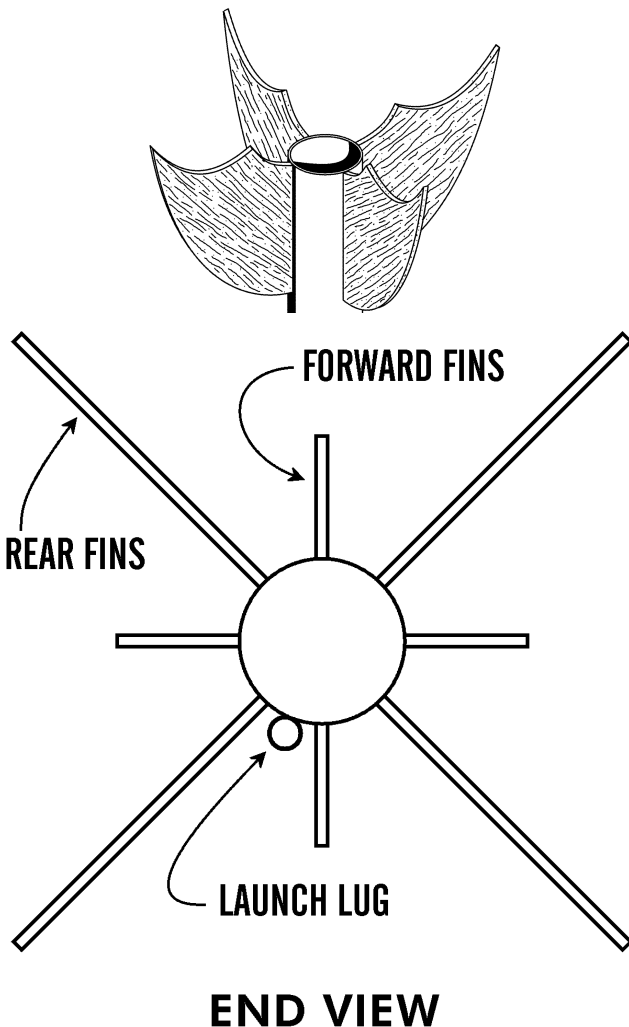

FINAL ASSEMBLY

- ❑ 19. Assemble chute using instructions printed on canopy. Attach chute by passing the lines through the screw eye and looping them over the tip of the payload section as shown. Pull the lines tight and make sure they are all of equal length. Put a drop of glue on the joint to keep the lines from moving.

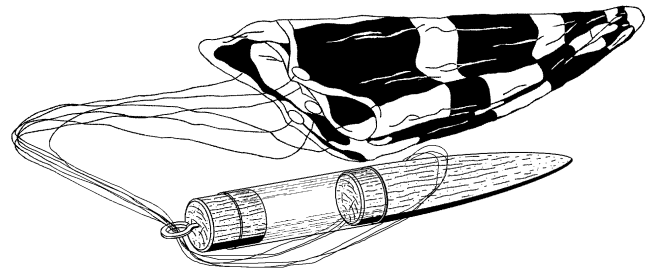

- ❑ 20. Pull the shock cord and Kevlar® thread out of the aft end of the BatRok™. Tie the loose end of the elastic cord to the screw eye. Put a drop of glue on the knot to keep it from untying. **NOTE: This is different from the usual method of passing the shock cord out of the top of the model rocket.** The fins will tangle the chute unless it comes down in a reverse direction.

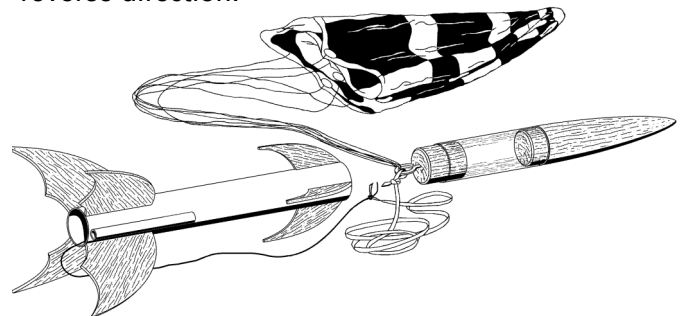

This completes the assembly of your

BatRok

PAYLOAD

- ❑ **14.** Insert the nose cone in the clear plastic tube (payload body) and check for proper fit. The nose cone should be snug to hold itself in alignment. If it is too loose, add masking tape. If it is too tight, sand the shoulder slightly.

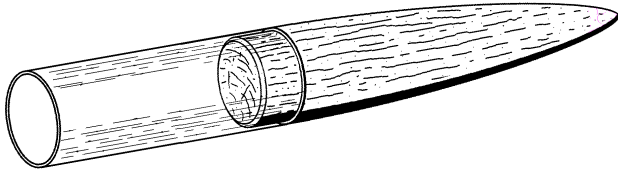

- ❑ **15.** Place a mark at the midway point on the balsa tube coupler.

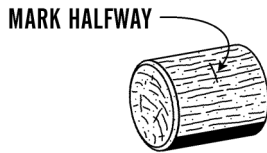

- ❑ **16.** Apply a thin bead of Super Glue or Cyanoacrylate (CA) glue just inside one end of the clear plastic tube.

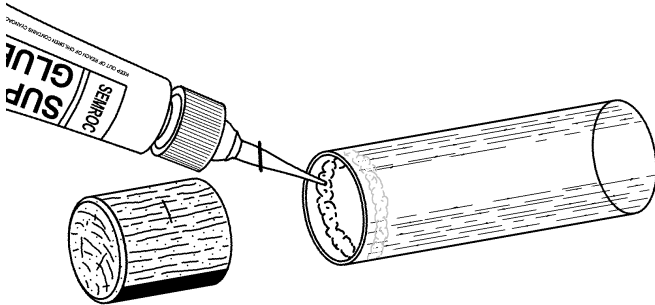

- ❑ **17.** Insert the balsa tube coupler into the payload tube until the mark is even with the end of the tube.

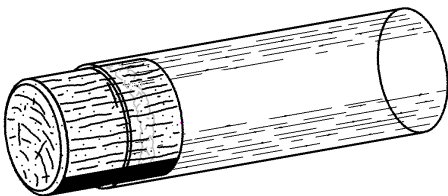

- ❑ **18.** Twist the screw eye into the center of the base of the balsa tube coupler. Unscrew it and squirt glue into the hole. Reinstall the screw eye and wipe off any excess glue.

- ❑ **11.** Apply the four forward fins in the same manner as the rear fins. Make sure they are on alternate lines from the rear fins as shown on the end view.

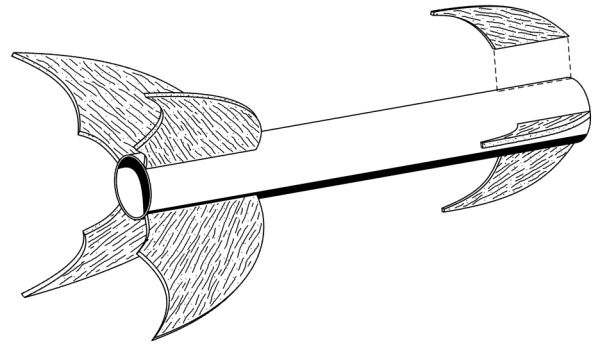

- ❑ **12.** After the fin assembly is completely dry, run a small bead of glue along both sides of each fin-body tube joint. Using your forefinger, smooth the glue into fillets.

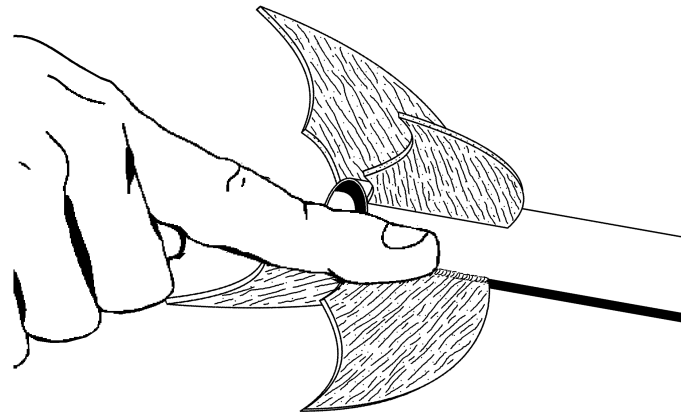

- ❑ **13.** Glue the launch lug onto the body tube, centered between one forward and one rear fin as shown in the end view and even with the bottom of the body tube. Stand the assembly vertically again and wait for the fin fillets to completely dry. Watch for runs in the glue and wipe them away before they run down the tube.

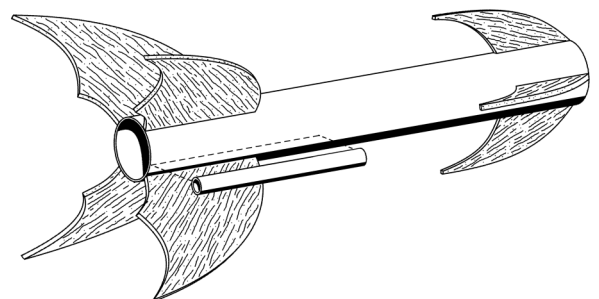

Parts List

Exploded View

- A) 1 Body Tube ST-765
- B) 1 Clear Plastic Tube..... CPT-719
- C) 1 Balsa Nose Cone..... BC-731
- D) 1 Balsa Tube Coupler BTC-7
- E) 1 Laser Cut Fins FV-53
- F) 1 Thrust Ring TR-7
- G) 1 Empty Casing MC-727
- H) 1 Launch Lug..... LL-122
- I) 1 Screw Eye SE-10
- J) 1 Elastic Cord EC-118
- K) 1 Kevlar Thread Black SCB-24
- L) 1 Plastic Parachute RC-12
- M) 1 Tape Discs TD-6
- N) 1 Shroud Line SLT-6
- O) 1 Decal..... DKV-53

